

4BTA3.9-G3



> Specification sheet

Our energy working for you.™



Description

The B3.9 has all the strength and reliability the genset industry has come to expect from the B Series range. The B3.9 features direct fuel injection, resulting in cleaner quieter and more fuel efficient performance.



This engine has been built to comply with CE certification.



This engine has been designed in facilities certified to ISO9001 and manufactured in facilities certified to ISO9001 or ISO9002.

Features

Coolpac Integrated Design - Supplied with cooling package and air cleaner kit for a complete power package.

Single Poly Vee belt drive for fan, alternator and water pump, with self-tensioning idler for minimum maintenance.

Stanadyne DB4 injection pump features advance mechanism for reliable cold starting.

Spin-on fuel filter and full-flow lubricating oil filter.

Top mounted Holset HX30 turbocharger for increased power, fuel economy and lower smoke and noise levels.

Service and Support - G-Drive products are backed by an uncompromising level of technical support and after sales service, delivered through a world class service network.

1500 rpm (50 Hz) Ratings

Gross Engine Output			Net Engine Output			Typical Generator Set Output					
Standby	Prime	Base	Standby	Prime	Base	Standby (ESP)		Prime (PRP)		Base (COP)	
kWm/BHP			kWm/BHP			kWe	kVA	kWe	kVA	kWe	kVA
81/108	73/97	RTF	78/105	70/94	RTF	30	38	28	35	RTF	RTF

1800 rpm (60 Hz) Ratings

Gross Engine Output			Net Engine Output			Typical Generator Set Output					
Standby	Prime	Base	Standby	Prime	Base	Standby (ESP)		Prime (PRP)		Base (COP)	
kWm/BHP			kWm/BHP			kWe	kVA	kWe	kVA	kWe	kVA
97/130	87/117	RTF	93/125	84/113	RTF	80	100	73	91	RTF	RTF

Our energy working for you.™

www.cumminsdrive.com

©2007 | Cummins G-Drive Engines | Specifications subject to change without notice | Cummins are registered trademarks of Cummins Inc. (01/08) (GDSS103-RevA)



General Engine Data

Type	4 cycle, in-line, Turbo Charged
Bore mm	102 mm (4.02 in.)
Stroke mm	120 mm (4.72 in.)
Displacement Litre	3.9 litre (293.3 in. ³)
Cylinder Block	Cast iron, 4 cylinder
Battery Charging Alternator	65 amps
Starting Voltage	12 volt, 65 Amp negative ground
Fuel System	Direct injection
Fuel Filter	Spin-on fuel filters with water separator
Lube Oil Filter Type(s)	Spin-on full flow filter
Lube Oil Capacity (l)	10.9
Flywheel Dimensions	3/11.5

Coolpac Performance Data

Cooling System Design	Jacket Water After Cooled
Coolant Ratio	50% ethlene glycol; 50% water
Coolant Capacity (l)	15.0
Limiting Ambient Temp.**	50.0
Fan Power	0.6
Cooling system air flow (m ³ /s)**	48.0
Air Cleaner Type	Dry replaceable element with retriiction indicator

** @ 13 mm H₂O

Weights & Dimension

Length	Width	Height	Weight (dry)
mm	mm	mm	kg
1110	630	870	350

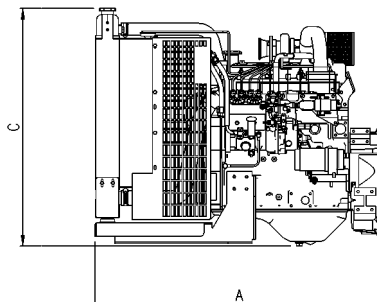
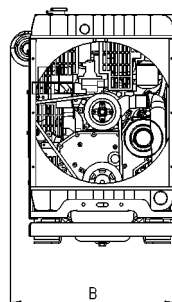

Fuel Consumption 1500 (50 Hz)

%	kWm	BHP	L/ph	US gal/ph
Standby Power				
100	81	108	21	5.5
Prime Power				
100	73	97	18	4.9
75	61	82	14	3.7
50	41	55	9	2.5
25	20	27	5	1.4
Continuous Power				
100	RTF	RTF	RTF	RTF

Fuel Consumption 1800 (60 Hz)

%	kWm	BHP	L/ph	US gal/ph
Standby Power				
100	97	130	25	6.5
Prime Power				
100	87	117	22	5.9
75	65	87	17	4.5
50	44	59	12	3.3
25	22	29	7	1.9
Continuous Power				
100	RTF	RTF	RTF	RTF

Cummins G-Drive Engines

Asia Pacific

10 Toh Guan Road
#07-01
TT International Tradepark
Singapore 608838
Phone 65 6417 2388
Fax 65 6417 2399

Europe, CIS, Middle

East and Africa
Manston Park Columbus Ave
Manston Ramsgate
Kent CT12 5BF. UK
Phone 44 1843 255000
Fax 44 1843 255902

Latin America

Rua Jati, 310, Cumbica
Guarulhos, SP 07180-900
Brazil
Phone 55 11 2186 4552
Fax 55 11 2186 4729

Mexico

Cummins S. de R.L. de C.V.
Eje 122 No. 200 Zona Industrial
San Luis Potosí, S.L.P. 78090
Mexico
Phone 52 444 870 6700
Fax 52 444 870 6811

North America

1400 73rd Avenue N.E.
Minneapolis, MN 55432
USA
Phone 1 763 574 5000
USA Toll-free 1 877 769 7669
Fax 1 763 574 5298

Our energy working for you.™

www.cumminsgdrive.com

©2007 | Cummins G-Drive Engines | Specifications subject to change without notice | Cummins are registered trademarks of Cummins Inc. (01/08) (GDSS103-RevA)

Ratings Definitions

Emergency Standby Power (ESP):

Applicable for supplying power to varying electrical load for the duration of power interruption of a reliable utility source. Emergency Standby Power (ESP) is in accordance with ISO 8528. Fuel Stop power in accordance with ISO 3046, AS 2789, DIN 6271 and BS 5514.

Limited-Time Running Power (LTP):

Applicable for supplying power to a constant electrical load for limited hours. Limited-Time Running Power (LTP) is in accordance with ISO 8528.

Prime Power (PRP):

Applicable for supplying power to varying electrical load for unlimited hours. Prime Power (PRP) is in accordance with ISO 8528. Ten percent overload capability is available in accordance with ISO 3046, AS 2789, DIN 6271 and BS 5514.

Base Load (Continuous) Power (COP):

Applicable for supplying power continuously to a constant electrical load for unlimited hours. Continuous Power (COP) in accordance with ISO 8528, ISO 3046, AS 2789, DIN6271 and BS 5514.



STAMFORD[®]

UCI224C - Technical Data Sheet

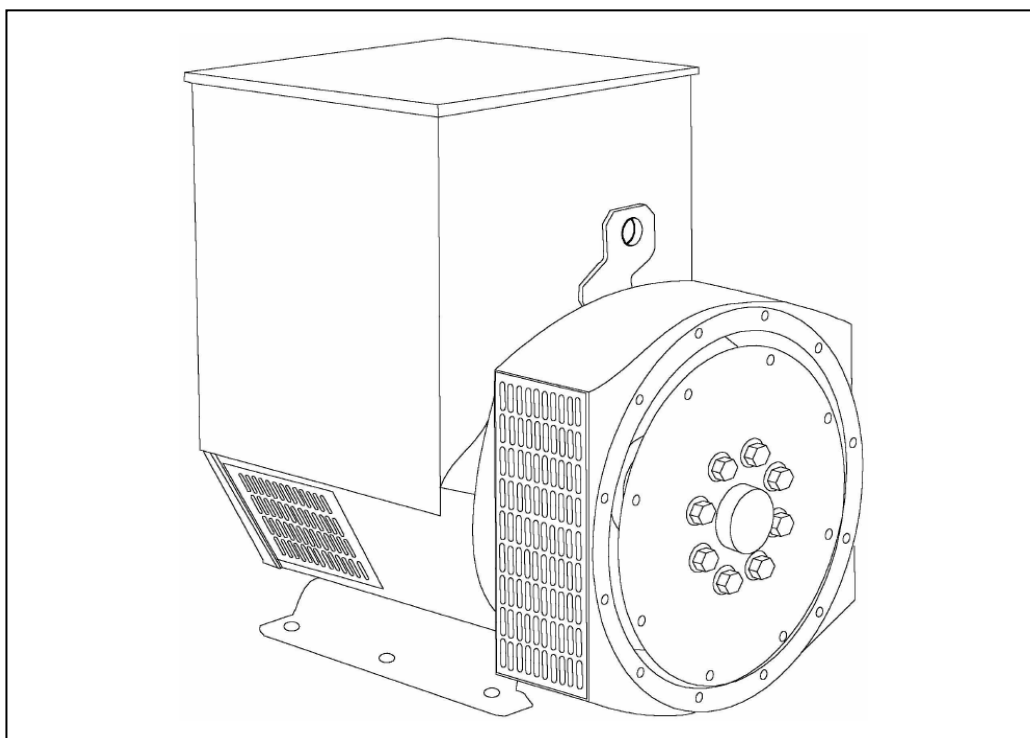

UCI224C

SPECIFICATIONS & OPTIONS

STAMFORD

STANDARDS

Newage Stamford industrial generators meet the requirements of BS EN 60034 and the relevant section of other international standards such as BS5000, VDE 0530, NEMA MG1-32, IEC34, CSA C22.2-100, AS1359. Other standards and certifications can be considered on request.

VOLTAGE REGULATORS

SX460 AVR - STANDARD

With this self excited control system the main stator supplies power via the Automatic Voltage Regulator (AVR) to the exciter stator. The high efficiency semiconductors of the AVR ensure positive build-up from initial low levels of residual voltage.

The exciter rotor output is fed to the main rotor through a three phase full wave bridge rectifier. This rectifier is protected by a surge suppressor against surges caused, for example, by short circuit.

AS440 AVR

With this self-excited system the main stator provides power via the AVR to the exciter stator. The high efficiency semi-conductors of the AVR ensure positive build-up from initial low levels of residual voltage.

The exciter rotor output is fed to the main rotor through a three-phase full-wave bridge rectifier. The rectifier is protected by a surge suppressor against surges caused, for example, by short circuit or out-of-phase paralleling.

The AS440 will support a range of electronic accessories, including a 'droop' Current Transformer (CT) to permit parallel operation with other ac generators.

MX341 AVR

This sophisticated AVR is incorporated into the Stamford Permanent Magnet Generator (PMG) control system.

The PMG provides power via the AVR to the main exciter, giving a source of constant excitation power independent of generator output. The main exciter output is then fed to the main rotor, through a full wave bridge, protected by a surge suppressor. The AVR has in-built protection against sustained over-excitation, caused by internal or external faults. This de-excites the machine after a minimum of 5 seconds.

An engine relief load acceptance feature can enable full load to be applied to the generator in a single step.

If three-phase sensing is required with the PMG system the MX321 AVR must be used.

We recommend three-phase sensing for applications with greatly unbalanced or highly non-linear loads.

MX321 AVR

The most sophisticated of all our AVRs combines all the features of the MX341 with, additionally, three-phase rms sensing, for improved regulation and performance.

Over voltage protection is built-in and short circuit current level adjustments is an optional facility.

WINDINGS & ELECTRICAL PERFORMANCE

All generator stators are wound to 2/3 pitch. This eliminates triplen (3rd, 9th, 15th ...) harmonics on the voltage waveform and is found to be the optimum design for trouble-free supply of non-linear loads. The 2/3 pitch design avoids excessive neutral currents sometimes seen with higher winding pitches, when in parallel with the mains. A fully connected damper winding reduces oscillations during paralleling. This winding, with the 2/3 pitch and carefully selected pole and tooth designs, ensures very low waveform distortion.

TERMINALS & TERMINAL BOX

Standard generators are 3-phase reconnectable with 12 ends brought out to the terminals, which are mounted on a cover at the non-drive end of the generator. A sheet steel terminal box contains the AVR and provides ample space for the customers' wiring and gland arrangements. It has removable panels for easy access.

SHAFT & KEYS

All generator rotors are dynamically balanced to better than BS6861:Part 1 Grade 2.5 for minimum vibration in operation. Two bearing generators are balanced with a half key.

INSULATION/IMPREGNATION

The insulation system is class 'H'.

All wound components are impregnated with materials and processes designed specifically to provide the high build required for static windings and the high mechanical strength required for rotating components.

QUALITY ASSURANCE

Generators are manufactured using production procedures having a quality assurance level to BS EN ISO 9001.

The stated voltage regulation may not be maintained in the presence of certain radio transmitted signals. Any change in performance will fall within the limits of Criteria 'B' of EN 61000-6-2:2001. At no time will the steady-state voltage regulation exceed 2%.

NB Continuous development of our products entitles us to change specification details without notice, therefore they must not be regarded as binding.

Front cover drawing typical of product range.

50
Hz

UCI224C
Winding 311

STAMFORD

THREE PHASE EFFICIENCY CURVES

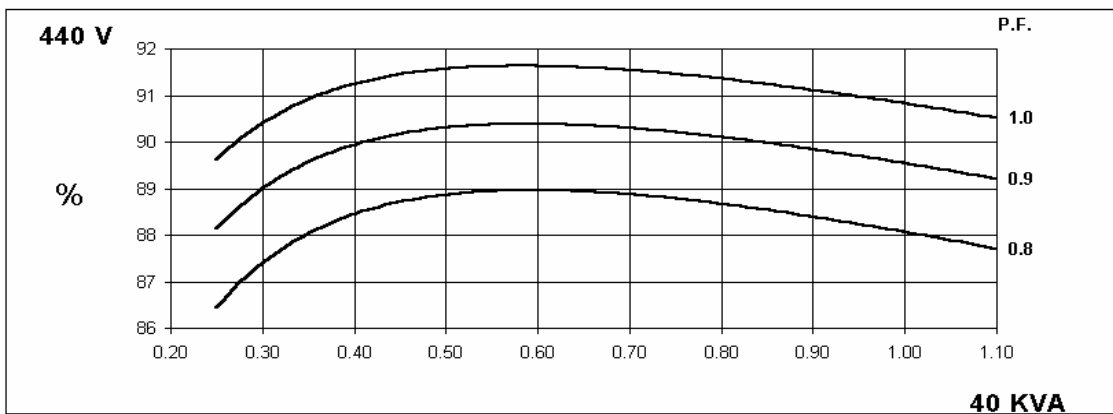
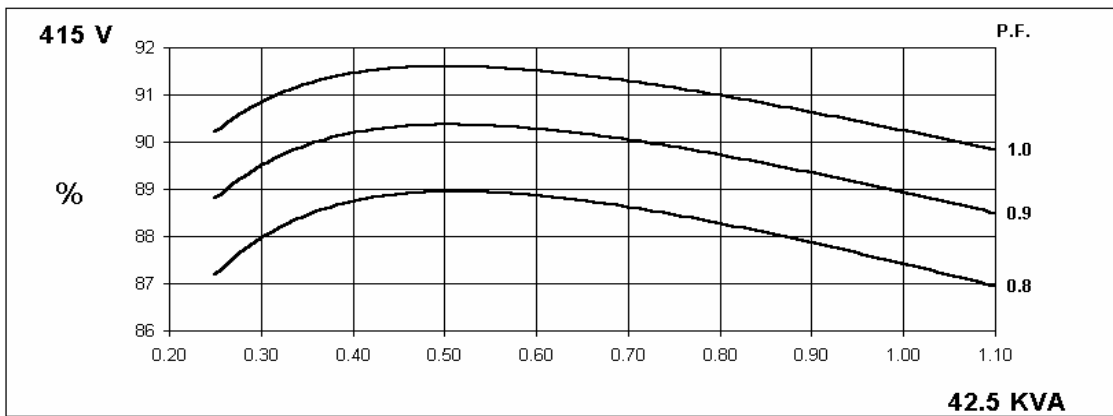
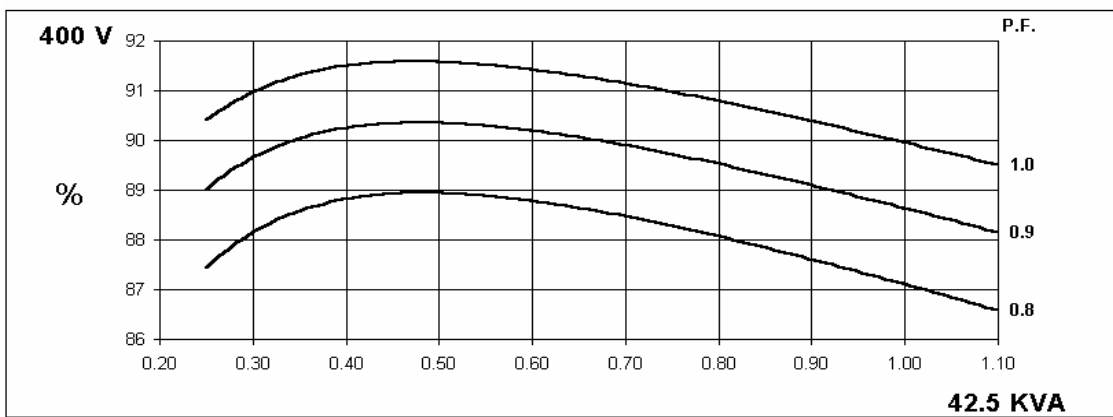
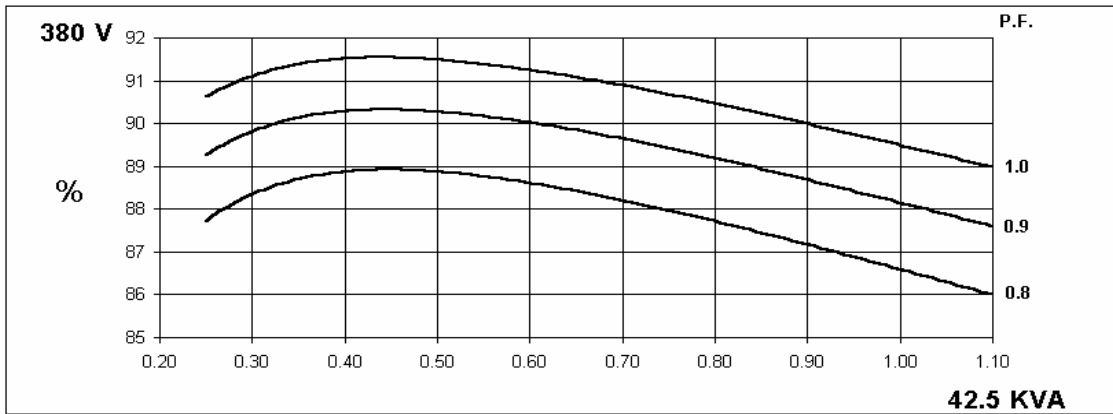

60
Hz

UCI224C
Winding 311

STAMFORD

THREE PHASE EFFICIENCY CURVES

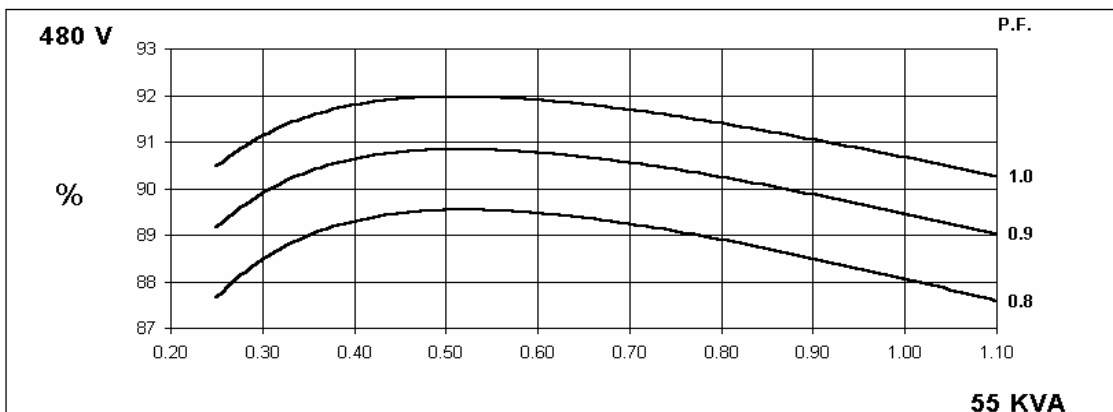
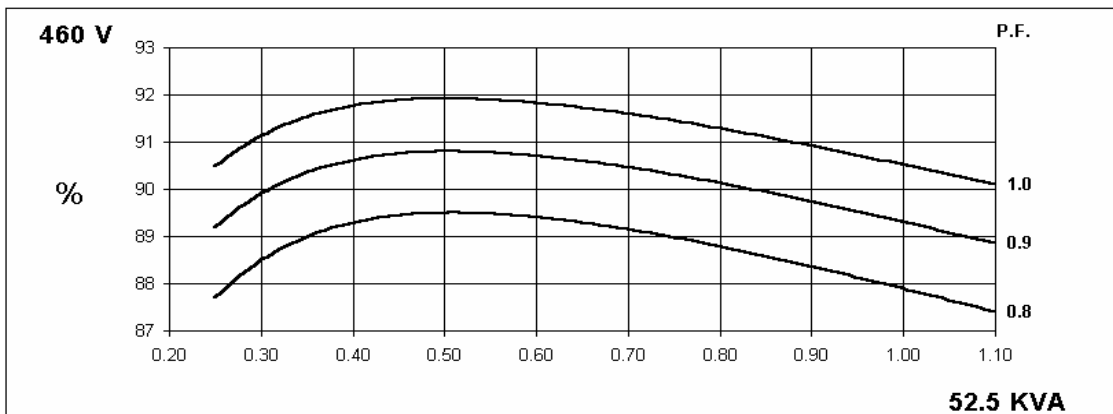
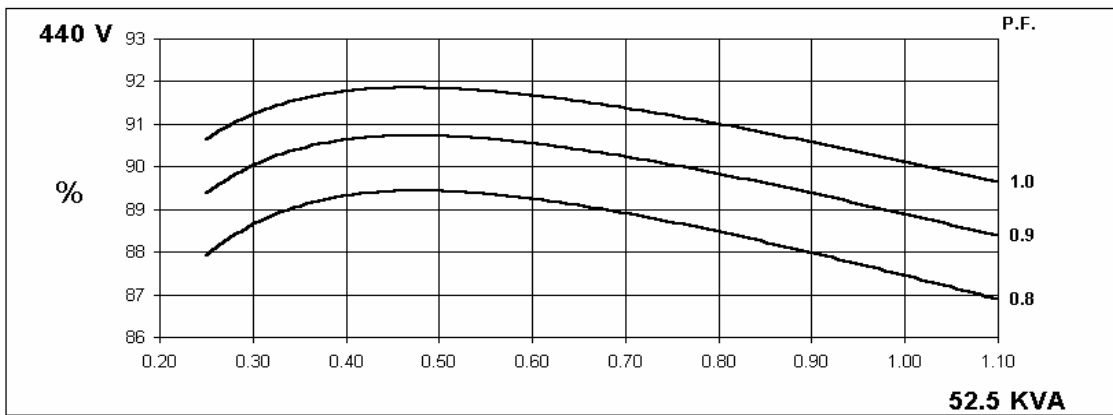
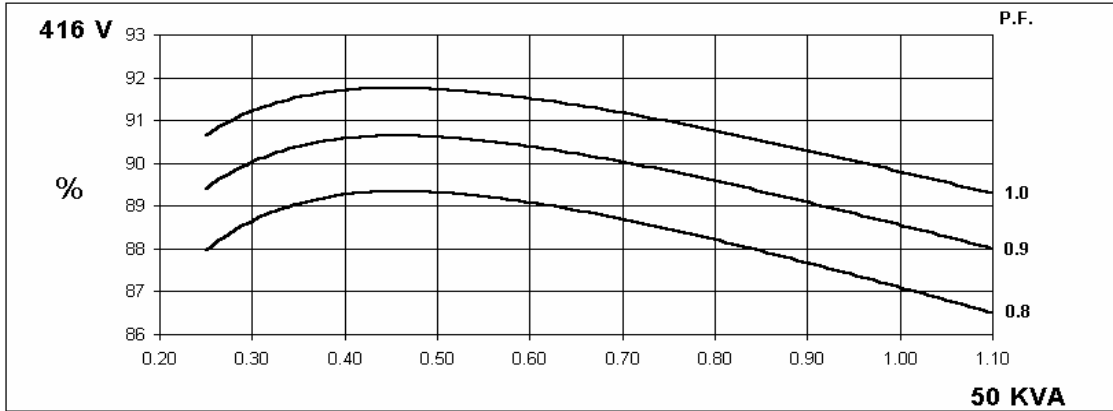

UCI224C
Winding 311

STAMFORD

Locked Rotor Motor Starting Curve

50
Hz

MX

SX

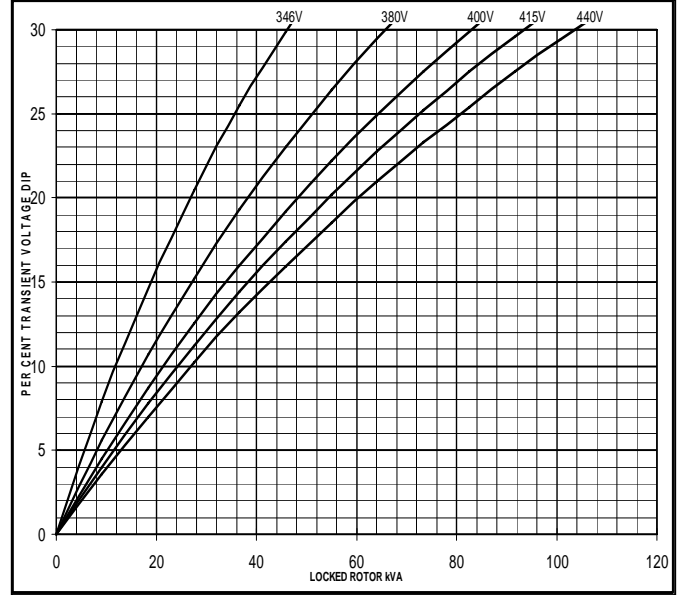
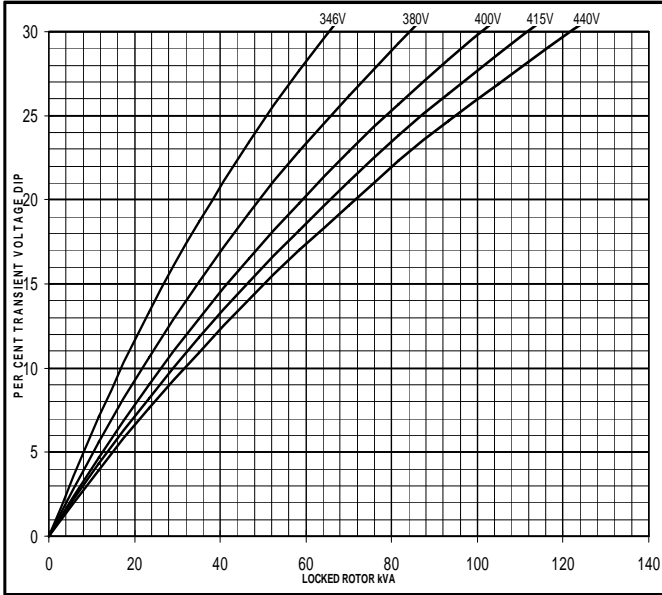

60
Hz

MX

SX

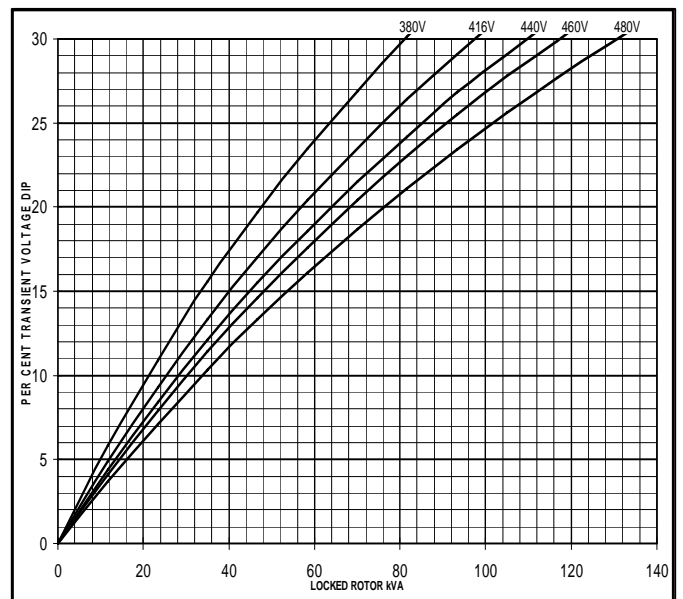
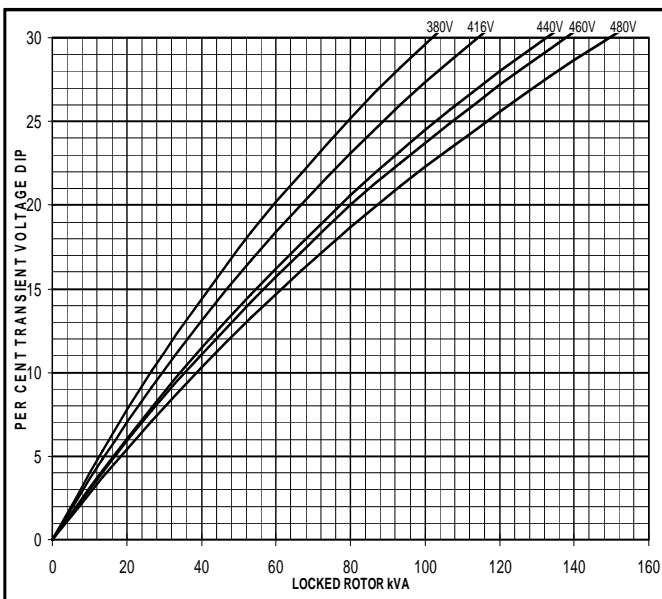

**Three-phase Short Circuit Decrement Curve. No-load Excitation at Rated Speed
Based on star (wye) connection.**

50
Hz

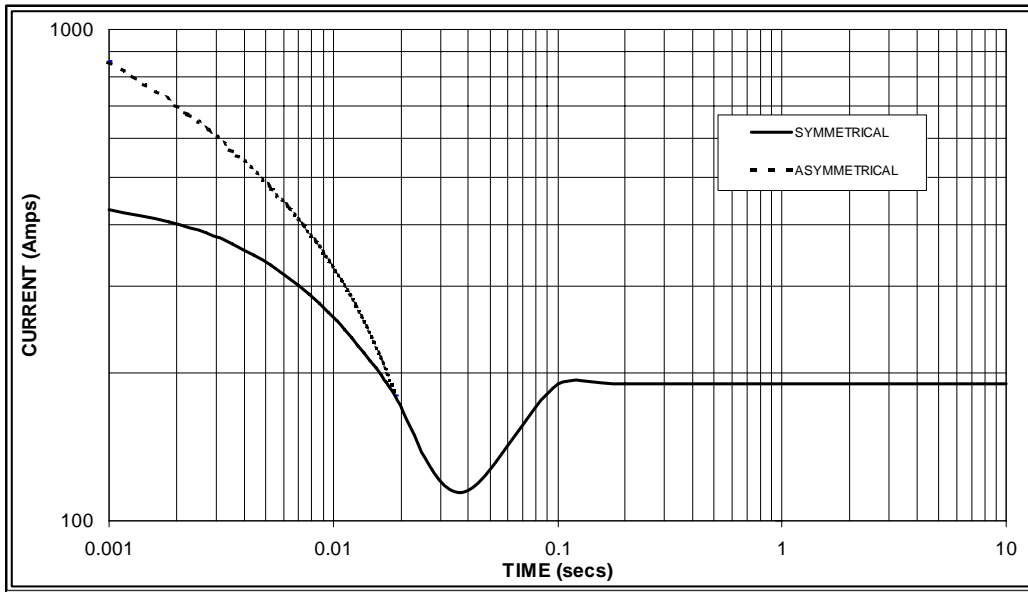

Sustained Short Circuit = 190 Amps

60
Hz

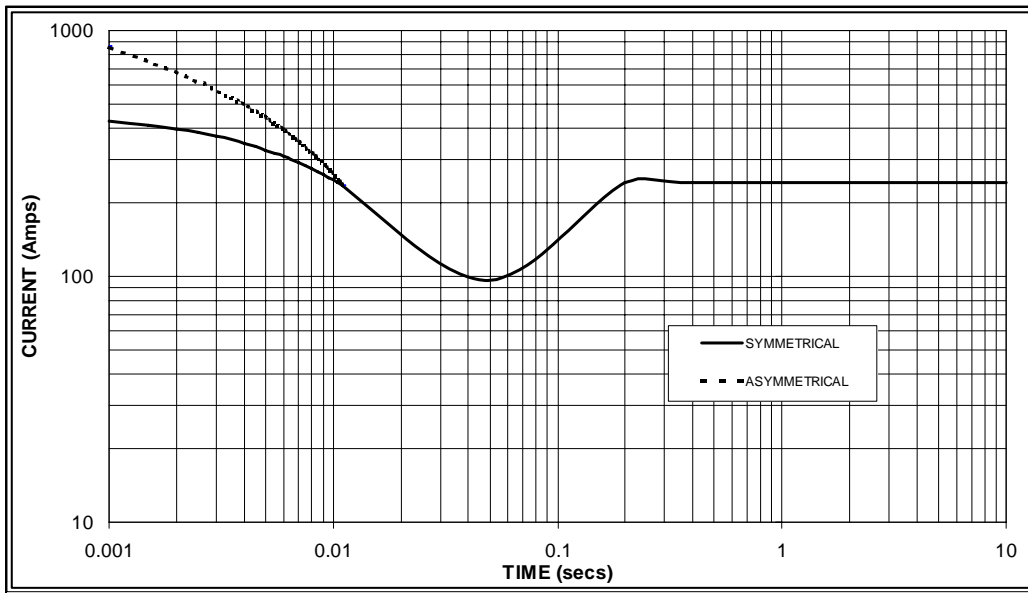

Sustained Short Circuit = 240 Amps

Note 1

The following multiplication factors should be used to adjust the values from curve between time 0.001 seconds and the minimum current point in respect of nominal operating voltage :

50Hz		60Hz	
Voltage	Factor	Voltage	Factor
380v	X 1.00	416v	X 1.00
400v	X 1.07	440v	X 1.06
415v	X 1.12	460v	X 1.12
440v	X 1.18	480v	X 1.17

The sustained current value is constant irrespective of voltage level

Note 2

The following multiplication factor should be used to convert the values calculated in accordance with NOTE 1 to those applicable to the various types of short circuit :

	3-phase	2-phase L-L	1-phase L-N
Instantaneous	x 1.00	x 0.87	x 1.30
Minimum	x 1.00	x 1.80	x 3.20
Sustained	x 1.00	x 1.50	x 2.50
Max. sustained duration	10 sec.	5 sec.	2 sec.

All other times are unchanged

Note 3

Curves are drawn for Star (Wye) connected machines. For other connection the following multipliers should be applied to current values as shown :

Parallel Star = Curve current value X 2

Series Delta = Curve current value X 1.732

UCI224C

STAMFORD

Winding 311 / 0.8 Power Factor

RATINGS

Class - Temp Rise	Cont. F - 105/40°C				Cont. H - 125/40°C				Standby - 150/40°C				Standby - 163/27°C				
50 Hz	Series Star (V)	380	400	415	440	380	400	415	440	380	400	415	440	380	400	415	440
	Parallel Star (V)	190	200	208	220	190	200	208	220	190	200	208	220	190	200	208	220
	Series Delta (V)	220	230	240	254	220	230	240	254	220	230	240	254	220	230	240	254
kVA	37.5	37.5	37.5	27.0	42.5	42.5	42.5	30.0	45.0	45.0	45.0	31.7	46.8	46.8	46.8	33.0	
kW	30.0	30.0	30.0	21.6	34.0	34.0	34.0	24.0	36.0	36.0	36.0	25.4	37.4	37.4	37.4	26.4	
Efficiency (%)	87.3	87.7	88.0	88.4	86.6	87.1	87.4	88.1	86.2	86.8	87.1	87.9	86.0	86.6	86.9	87.7	
kW Input	34.4	34.2	34.1	32.6	39.3	39.0	38.9	36.3	41.8	41.5	41.3	38.4	43.5	43.2	43.1	40.1	

60 Hz	Series Star (V)	416	440	460	480	416	440	460	480	416	440	460	480	416	440	460	480
	Parallel Star (V)	208	220	230	240	208	220	230	240	208	220	230	240	208	220	230	240
	Delta (V)	240	254	266	277	240	254	266	277	240	254	266	277	240	254	266	277
kVA	45.0	46.3	46.3	48.0	50.0	52.5	52.5	55.0	53.1	55.0	55.0	58.1	55.0	56.3	56.3	60.0	
kW	36.0	37.0	37.0	38.4	40.0	42.0	42.0	44.0	42.5	44.0	44.0	46.5	44.0	45.0	45.0	48.0	
Efficiency (%)	87.7	88.1	88.4	88.6	87.1	87.5	87.9	88.1	86.7	87.2	87.7	87.8	86.5	87.1	87.5	87.6	
kW Input	41.0	42.0	41.9	43.3	45.9	48.0	47.8	49.9	49.0	50.5	50.2	52.9	50.9	51.7	51.5	54.8	

DIMENSIONS

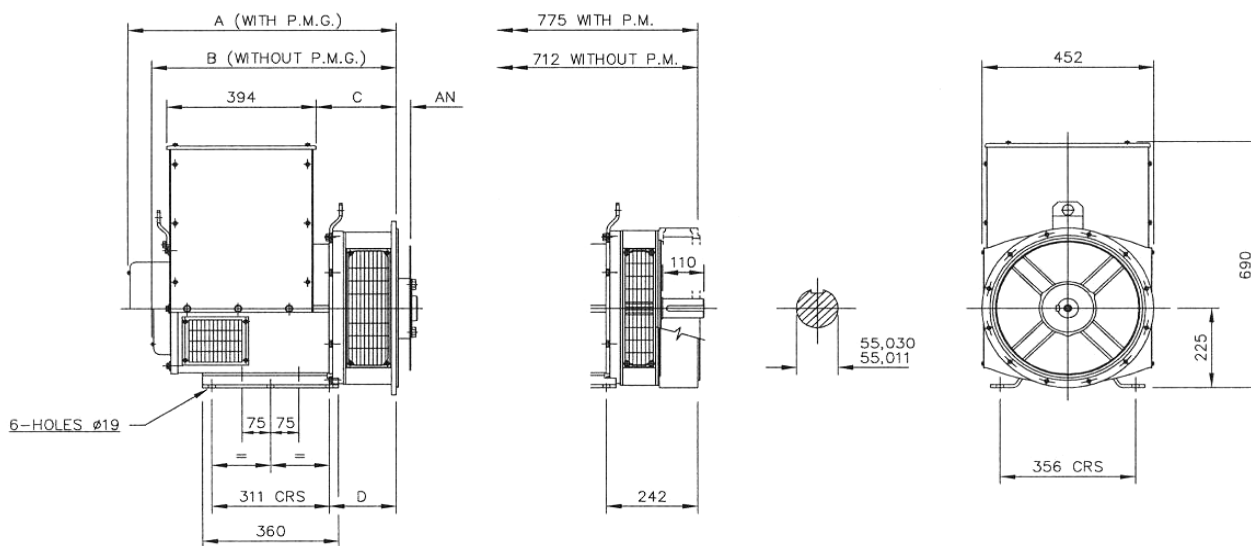

SINGLE BEARING MACHINES ONLY						
ADAPTOR	A	B	C	D	COUPLING DISCS	AN
SAE 1	724,3	661,3	224,3	191,3	SAE 8	61,90
SAE 2	710	647	210	177	SAE 10	53,98
SAE 3	710	647	210	177	SAE 11,5	39,68
SAE 4	710	647	210	177	SAE 14	25,40

STAMFORD

Barnack Road • Stamford • Lincolnshire • PE9 2NB

Tel: 00 44 (0)1780 484000 • Fax: 00 44 (0)1780 484100