

QSX15-G8

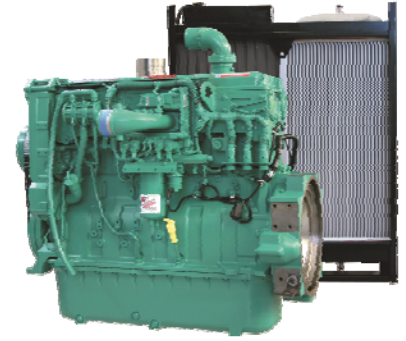

Emissions Compliance:

Non-Certified or "Flex" program for EU Mobile applications.
Formerly EU Stage2 @ 50Hz.

> Specification sheet



Our energy working for you.™

Description

The QSX15-Series is the first heavy-duty diesel with 24-valve dual overhead camshaft technology. Yet it has an impressive 30% fewer parts than comparable diesels and a utilised design, which eliminates external lube, coolant and fuel lines, leading to higher reliability for such a high power output.

The 15 litre, six-cylinder QSX15 engine is ideally suited to both open and containerised applications in static or portable genset equipment. It can be matched to meet specific duty cycle and operating conditions of any genset.



This engine has been built to comply with CE certification.



This engine has been designed in facilities certified to ISO9001 and manufactured in facilities certified to ISO9001 or ISO9002.

Features

Holset HX82 Turbocharging - Wastegated design optimizes operation. Improved transient response and low fuel consumption.

Integrated Block Design - Integrated fluid circuits replace hoses and eliminate potential leaks.

High-Pressure Fuel Injection - Capable of over 1,900 bar (28,000 psi) for cleaner, more fuel-efficient combustion.

24-Valve Cylinder Head – Four valves per cylinder for increased power with faster response at every rpm.

Coolpac Integrated Design - Products are supplied complete with cooling package and air cleaner kit for a complete power package. Each component has been specifically developed and rigorously tested for G-Drive products, ensuring high performance, durability and reliability.

Controls - Fitted with Power Generation Interface (PGI) to improve emissions.

Service and Support - G-Drive products are backed by an uncompromising level of technical support and after sales service, delivered through a world class service network.

1500 rpm (50 Hz Ratings)

Gross Engine Output			Net Engine Output			Typical Generator Set Output					
Standby	Prime	Base	Standby	Prime	Base	Standby (ESP)		Prime (PRP)		Base (COP)	
kWm/BHP			kWm/BHP			kWe	kVA	kWe	kVA	kWe	kVA
500/670	444/595	317/425	477/639	426/571	299/400	440	550	400	500	281	351

1800 rpm (60 Hz Ratings)

Gross Engine Output			Net Engine Output			Typical Generator Set Output					
Standby	Prime	Base	Standby	Prime	Base	Standby (ESP)		Prime (PRP)		Base (COP)	
kWm/BHP			kWm/BHP			kWe	kVA	kWe	kVA	kWe	kVA
455/610	414/555	295/395	419/561	383/513	264/354	400	500	360	450	248	310

Our energy working for you.™

www.cumminsgdrive.com

©201 | Cummins G-Drive Engines | Specifications Subject to Change Without Notice | Cummins is a registered trademarks of Cummins Inc. (03/11)



General Engine Data

Type	4 Cycle, In-line, Turbo Charged, Air Cooled
Bore mm	137 mm (5.39 in.)
Stroke mm	169 mm (6.65 in.)
Displacement Litre	15 litre (912 in. ³)
Cylinder Block	Cast iron, 6 cylinder
Battery Charging Alternator	35 amps
Starting Voltage	24 volt
Fuel System	Direct injection
Fuel Filter	Spin-on fuel filters with water separator
Lube Oil Filter Type(s)	Spin-on full flow filter
Lube Oil Capacity (l)	91.0
Flywheel Dimensions	SAE1

Coolpac Performance Data

Cooling System Design	Air-Air Charge Cooled
Coolant Ratio	50% ethylene glycol; 50% water
Coolant Capacity (l)	42.0
Limiting Ambient Temp.** (°C)	55
Fan Power (kWm)	16
Cooling System Air Flow (m ³ /s)**	11.8
Air Cleaner Type	Light duty dry replaceable element with restriction indicator

** @ 13 mm H₂O Duct Restriction

Weight & Dimensions

Length	Width	Height	Weight (dry)
mm	mm	mm	kg
2269	1332	1669	1658

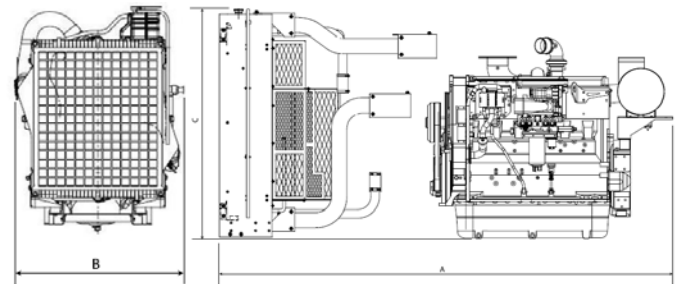

Fuel Consumption 1500 (50 Hz)

%	kWm	BHP	L/ph	US gal/ph
Standby Power				
100	500	670	123.0	32.4
Prime Power				
100	444	595	103.0	27.3
75	333	447	78.7	20.8
50	222	298	54.7	14.5
25	111	149	30.3	8
Continuous Power				
100	317	425	75.7	20

Fuel Consumption 1800 (60 Hz)

%	kWm	BHP	L/ph	US gal/ph
Standby Power				
100	455	610	107.0	28.4
Prime Power				
100	414	555	97.6	25.8
75	311	416	75.2	19.9
50	207	278	53.4	14.1
25	104	139	31.8	8.4
Continuous Power				
100	295	395	72.7	19.1

Cummins G-Drive Engines

Asia Pacific

10 Toh Guan Road
#07-01
TT International Tradepark
Singapore 608838
Phone 65 6417 2388
Fax 65 6417 2399

Europe, CIS, Middle

East and Africa
Manston Park Columbus Ave
Manston Ramsgate
Kent CT12 5BF. UK
Phone 44 1843 255000
Fax 44 1843 255902

Latin America

Rua Jati, 310, Cumbica
Guarulhos, SP 07180-900
Brazil
Phone 55 11 2186 4552
Fax 55 11 2186 4729

Mexico

Cummins S. de R.L. de C.V.
Eje 122 No. 200 Zona Industrial
San Luis Potosi, S.L.P. 78090
Mexico
Phone 52 444 870 6700
Fax 52 444 870 6811

North America

1400 73rd Avenue N.E.
Minneapolis, MN 55432
USA
Phone 1 763 574 5000
USA Toll-free 1 877 769 7669
Fax 1 763 574 5298

Our energy working for you.™

www.cumminsgdrive.com

©201 | Cummins G-Drive Engines | Specifications Subject to Change Without Notice | Cummins is a registered trademarks of Cummins Inc. (03/11)



Ratings Definitions

Emergency Standby Power (ESP):

Applicable for supplying power to varying electrical load for the duration of power interruption of a reliable utility source. Emergency Standby Power (ESP) is in accordance with ISO 8528. Fuel Stop power in accordance with ISO 3046, AS 2789, DIN 6271 and BS 5514.

Limited-Time Running Power (LTP):

Applicable for supplying power to a constant electrical load for limited hours. Limited-Time Running Power (LTP) is in accordance with ISO 8528.

Prime Power (PRP):

Applicable for supplying power to varying electrical load for unlimited hours. Prime Power (PRP) is in accordance with ISO 8528. Ten percent overload capability is available in accordance with ISO 3046, AS 2789, DIN 6271 and BS 5514.

Base Load (Continuous) Power (COP):

Applicable for supplying power continuously to a constant electrical load for unlimited hours. Continuous Power (COP) is in accordance with ISO 8528, ISO 3046, AS 2789, DIN6271 and BS 5514.

Our energy working for you.™

www.cumminsgdrive.com

©201 | Cummins G-Drive Engines | Specifications Subject to Change Without Notice | Cummins is a registered trademarks of Cummins Inc.
(03/11)



HCI 534C/544C - Technical Data Sheet

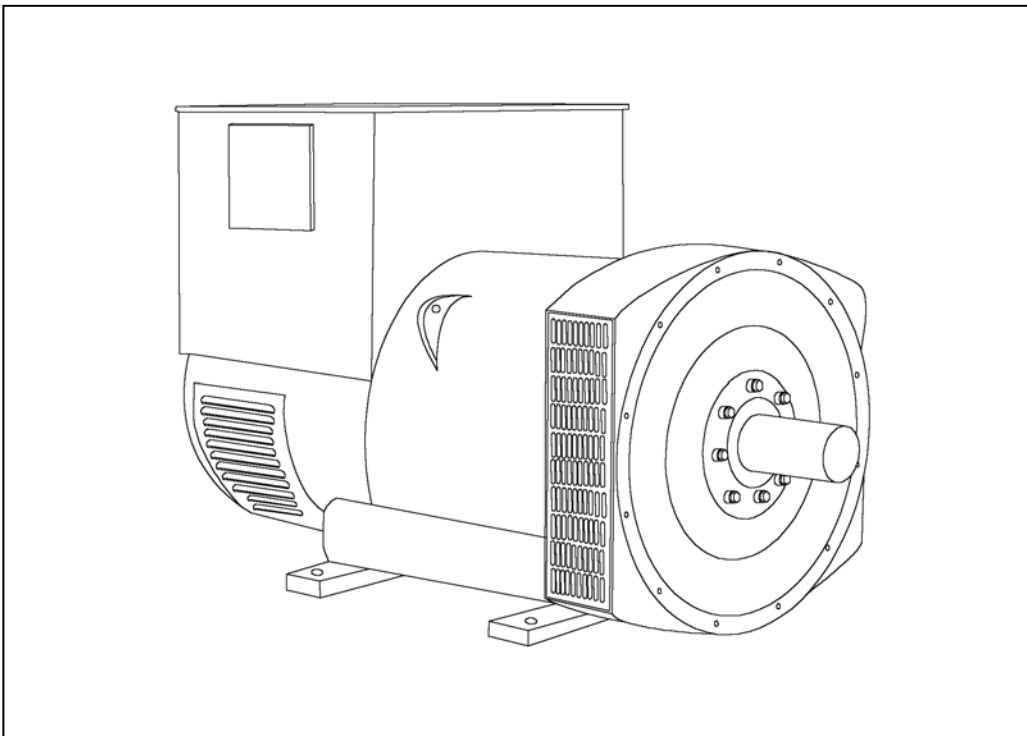

HCI534C/544C

SPECIFICATIONS & OPTIONS



STANDARDS

Newage Stamford industrial generators meet the requirements of BS EN 60034 and the relevant section of other international standards such as BS5000, VDE 0530, NEMA MG1-32, IEC34, CSA C22.2-100, AS1359. Other standards and certifications can be considered on request.

VOLTAGE REGULATORS

SX440 AVR - STANDARD

With this self-excited system the main stator provides power via the Automatic Voltage Regulator (AVR) to the exciter stator. The high efficiency semi-conductors of the AVR ensure positive build-up from initial low levels of residual voltage.

The exciter rotor output is fed to the main rotor through a three-phase full-wave bridge rectifier. The rectifier is protected by a surge suppressor against surges caused, for example, by short circuit or out-of-phase paralleling.

The SX440 will support a range of electronic accessories, including a 'droop' Current Transformer (CT) to permit parallel operation with other ac generators.

If 3-phase sensing is required with the self-excited system, the SX421 AVR must be used.

SX421 AVR

This AVR also operates in a self-excited system. It combines all the features of the SX440 with, additionally, three-phase rms sensing for improved regulation and performance. Over voltage protection is provided via a separate circuit breaker. An engine relief load acceptance feature is built in as standard.

MX341 AVR

This sophisticated AVR is incorporated into the Stamford Permanent Magnet Generator (PMG) control system.

The PMG provides power via the AVR to the main exciter, giving a source of constant excitation power independent of generator output. The main exciter output is then fed to the main rotor, through a full wave bridge, protected by a surge suppressor. The AVR has in-built protection against sustained over-excitation, caused by internal or external faults. This de-excites the machine after a minimum of 5 seconds.

An engine relief load acceptance feature can enable full load to be applied to the generator in a single step.

If three-phase sensing is required with the PMG system the MX321 AVR must be used.

We recommend three-phase sensing for applications with greatly unbalanced or highly non-linear loads.

MX321 AVR

The most sophisticated of all our AVRs combines all the features of the MX341 with, additionally, three-phase rms sensing, for improved regulation and performance.

Over voltage protection is built-in and short circuit current level adjustments is an optional facility.

WINDINGS & ELECTRICAL PERFORMANCE

All generator stators are wound to 2/3 pitch. This eliminates triplen (3rd, 9th, 15th ...) harmonics on the voltage waveform and is found to be the optimum design for trouble-free supply of non-linear loads. The 2/3 pitch design avoids excessive neutral currents sometimes seen with higher winding pitches, when in parallel with the mains. A fully connected damper winding reduces oscillations during paralleling. This winding, with the 2/3 pitch and carefully selected pole and tooth designs, ensures very low waveform distortion.

TERMINALS & TERMINAL BOX

Standard generators are 3-phase reconnectable with 12 ends brought out to the terminals, which are mounted on a cover at the non-drive end of the generator. A sheet steel terminal box contains the AVR and provides ample space for the customers' wiring and gland arrangements. It has removable panels for easy access.

SHAFT & KEYS

All generator rotors are dynamically balanced to better than BS6861:Part 1 Grade 2.5 for minimum vibration in operation. Two bearing generators are balanced with a half key.

INSULATION/IMPREGNATION

The insulation system is class 'H'.

All wound components are impregnated with materials and processes designed specifically to provide the high build required for static windings and the high mechanical strength required for rotating components.

QUALITY ASSURANCE

Generators are manufactured using production procedures having a quality assurance level to BS EN ISO 9001.

The stated voltage regulation may not be maintained in the presence of certain radio transmitted signals. Any change in performance will fall within the limits of Criteria 'B' of EN 61000-6-2:2001. At no time will the steady-state voltage regulation exceed 2%.

NB Continuous development of our products entitles us to change specification details without notice, therefore they must not be regarded as binding.

Front cover drawing typical of product range.

HCI534C/544C

WINDING 311

CONTROL SYSTEM	SEPARATELY EXCITED BY P.M.G.							
A.V.R.	MX321	MX341						
VOLTAGE REGULATION	± 0.5 %	± 1.0 %	With 4% ENGINE GOVERNING					
SUSTAINED SHORT CIRCUIT	REFER TO SHORT CIRCUIT DECREMENT CURVES (page 7)							
CONTROL SYSTEM	SELF EXCITED							
A.V.R.	SX440	SX421						
VOLTAGE REGULATION	± 1.0 %	± 0.5 %	With 4% ENGINE GOVERNING					
SUSTAINED SHORT CIRCUIT	SERIES 4 CONTROL DOES NOT SUSTAIN A SHORT CIRCUIT CURRENT							
INSULATION SYSTEM	CLASS H							
PROTECTION	IP23							
RATED POWER FACTOR	0.8							
STATOR WINDING	DOUBLE LAYER LAP							
WINDING PITCH	TWO THIRDS							
WINDING LEADS	12							
STATOR WDG. RESISTANCE	0.0065 Ohms PER PHASE AT 22°C SERIES STAR CONNECTED							
ROTOR WDG. RESISTANCE	1.55 Ohms at 22°C							
R.F.I. SUPPRESSION	BS EN 61000-6-2 & BS EN 61000-6-4,VDE 0875G, VDE 0875N. refer to factory for others							
WAVEFORM DISTORTION	NO LOAD < 1.5% NON-DISTORTING BALANCED LINEAR LOAD < 5.0%							
MAXIMUM OVERSPEED	2250 Rev/Min							
BEARING DRIVE END	BALL. 6220 (ISO)							
BEARING NON-DRIVE END	BALL. 6314 (ISO)							
	1 BEARING				2 BEARING			
WEIGHT COMP. GENERATOR	1263 kg				1275 kg			
WEIGHT WOUND STATOR	584 kg				584 kg			
WEIGHT WOUND ROTOR	502 kg				473 kg			
WR ² INERTIA	6.8928 kgm ²				6.6149 kgm ²			
SHIPPING WEIGHTS in a crate	1355 kg				1395 kg			
PACKING CRATE SIZE	166 x 87 x 124(cm)				166 x 87 x 124(cm)			
	50 Hz				60 Hz			
TELEPHONE INTERFERENCE	THF<2%				TIF<50			
COOLING AIR	1.035 m ³ /sec 2202 cfm				1.312 m ³ /sec 2780 cfm			
VOLTAGE SERIES STAR	380/220	400/231	415/240	440/254	416/240	440/254	460/266	480/277
VOLTAGE PARALLEL STAR	190/110	200/115	208/120	220/127	208/120	220/127	230/133	240/138
VOLTAGE SERIES DELTA	220/110	230/115	240/120	254/127	240/120	254/127	266/133	277/138
KVA BASE RATING FOR REACTANCE VALUES	450	450	450	450	525	550	581	594
X _d DIR. AXIS SYNCHRONOUS	3.27	2.95	2.74	2.44	3.94	3.69	3.57	3.35
X' _d DIR. AXIS TRANSIENT	0.18	0.16	0.15	0.13	0.18	0.17	0.16	0.15
X'' _d DIR. AXIS SUBTRANSIENT	0.13	0.12	0.11	0.10	0.13	0.12	0.12	0.11
X _q QUAD. AXIS REACTANCE	2.66	2.40	2.23	1.98	3.12	2.92	2.82	2.65
X'' _q QUAD. AXIS SUBTRANSIENT	0.26	0.24	0.22	0.20	0.34	0.32	0.31	0.29
X _L LEAKAGE REACTANCE	0.07	0.06	0.06	0.05	0.08	0.07	0.07	0.07
X ₂ NEGATIVE SEQUENCE	0.19	0.17	0.16	0.14	0.23	0.22	0.21	0.20
X ₀ ZERO SEQUENCE	0.11	0.10	0.09	0.08	0.11	0.10	0.10	0.09
REACTANCES ARE SATURATED VALUES ARE PER UNIT AT RATING AND VOLTAGE INDICATED								
T' _d TRANSIENT TIME CONST.	0.08s							
T'' _d SUB-TRANSTIME CONST.	0.012s							
T' _{do} O.C. FIELD TIME CONST.	2s							
T _a ARMATURE TIME CONST.	0.017s							
SHORT CIRCUIT RATIO	1/X _d							

**50
Hz**

HCI534C/544C
Winding 311



THREE PHASE EFFICIENCY CURVES

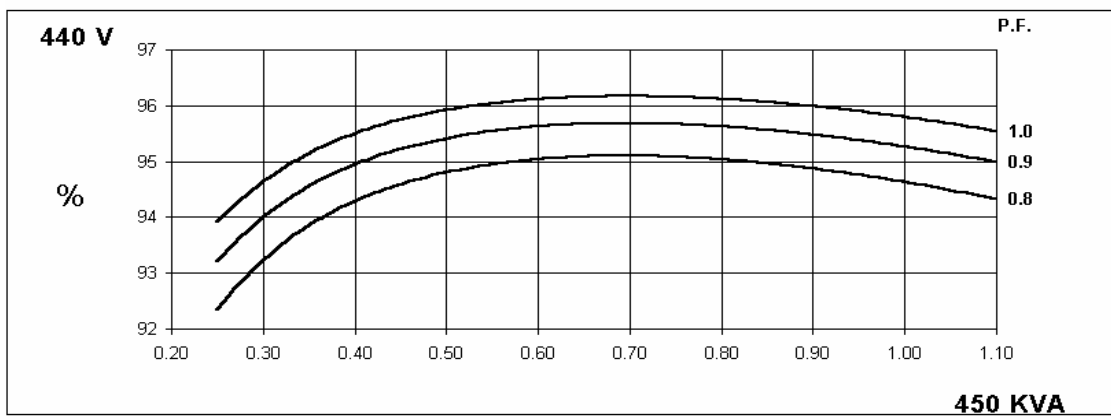
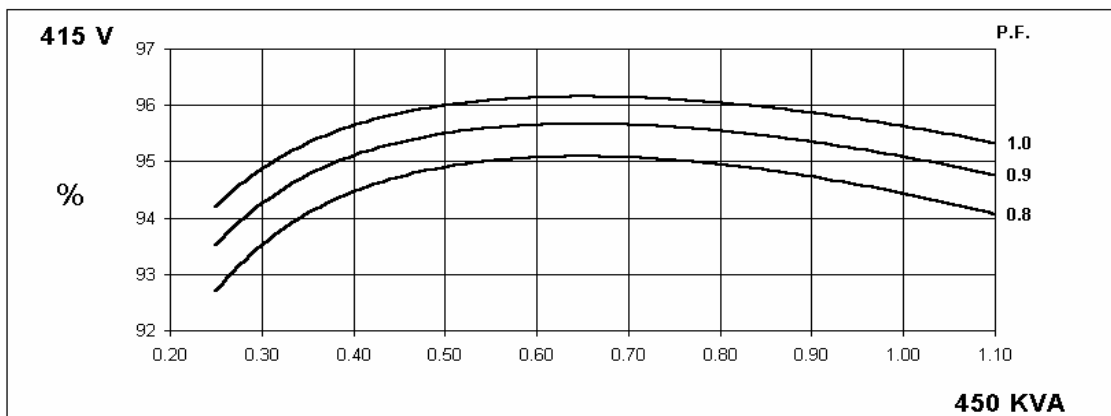
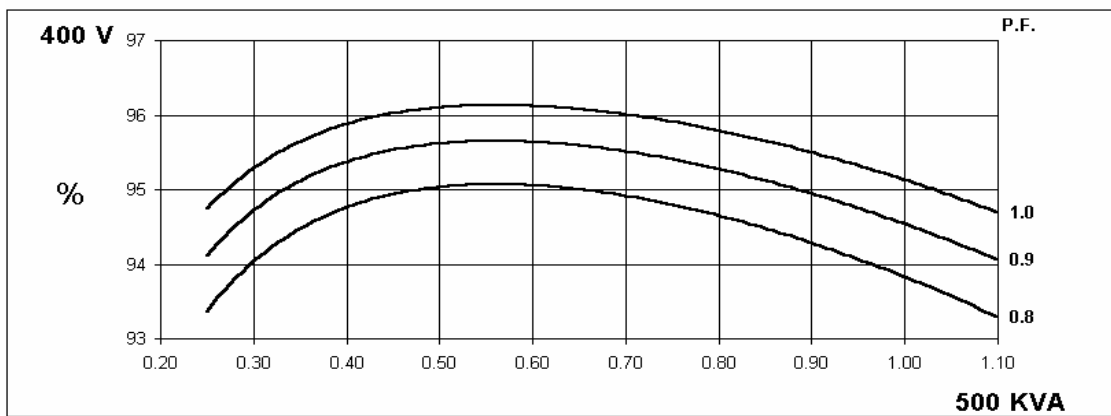
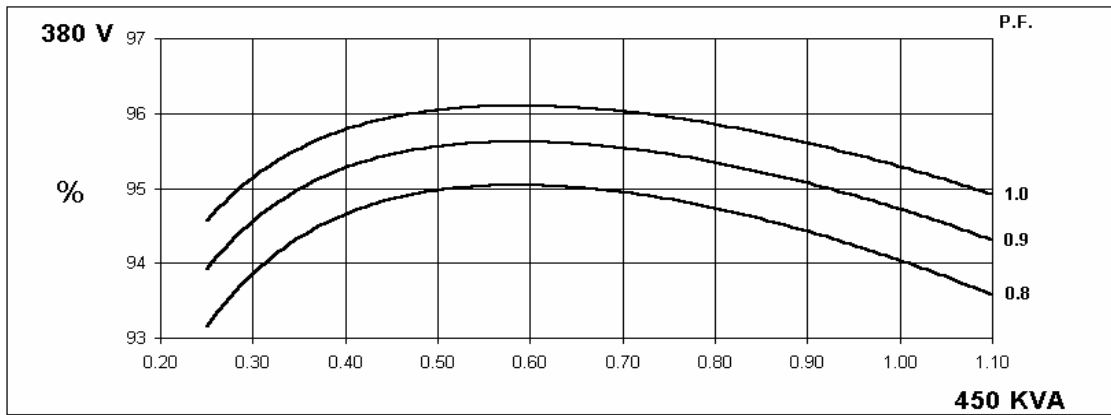

THREE PHASE EFFICIENCY CURVES

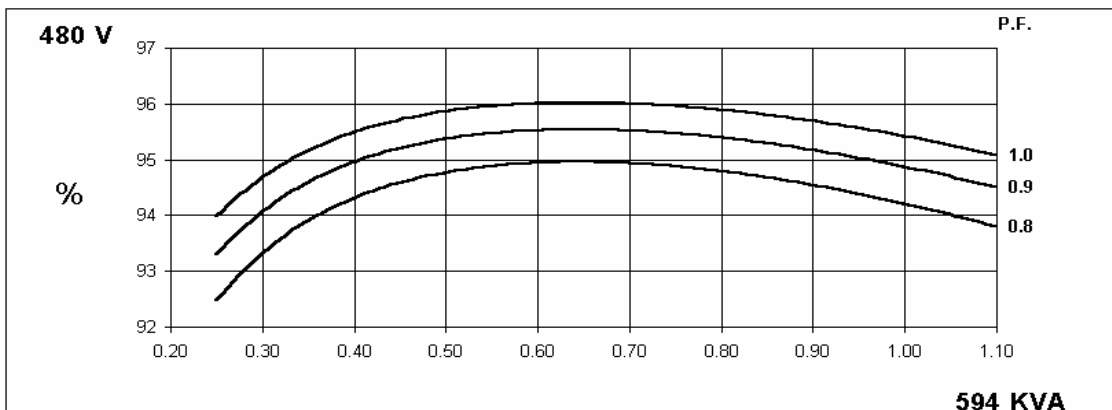
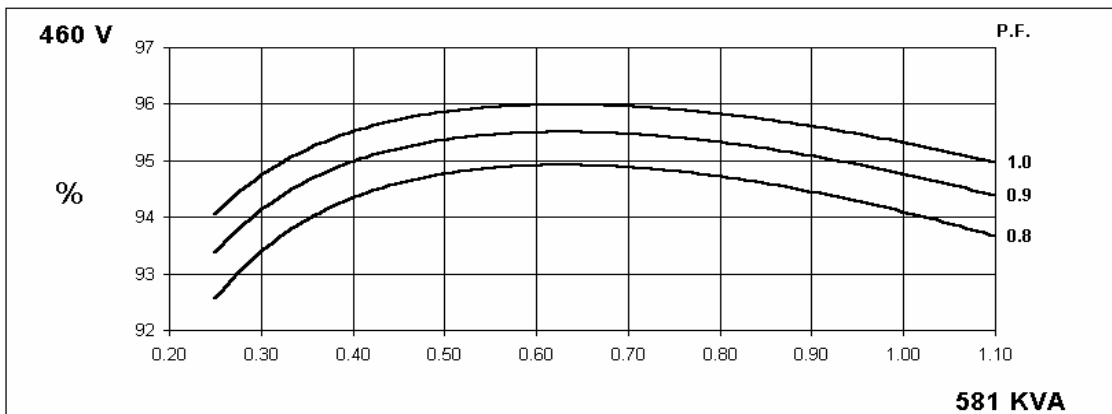
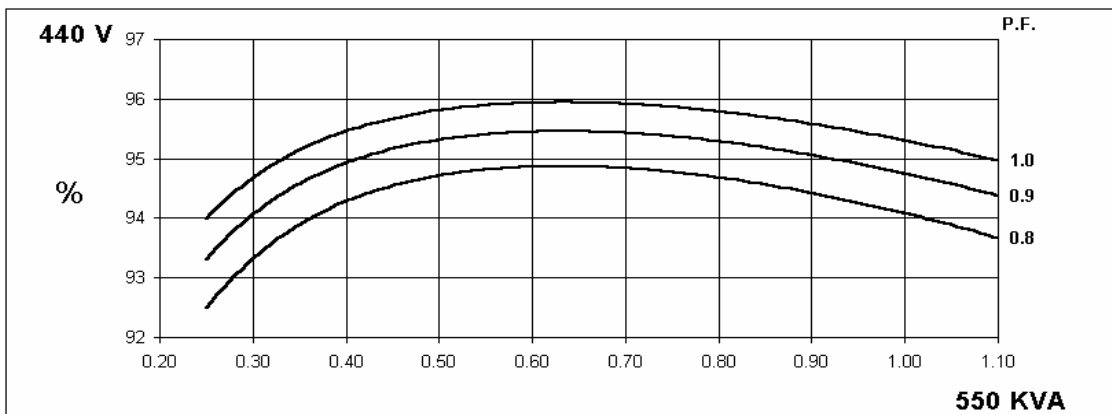
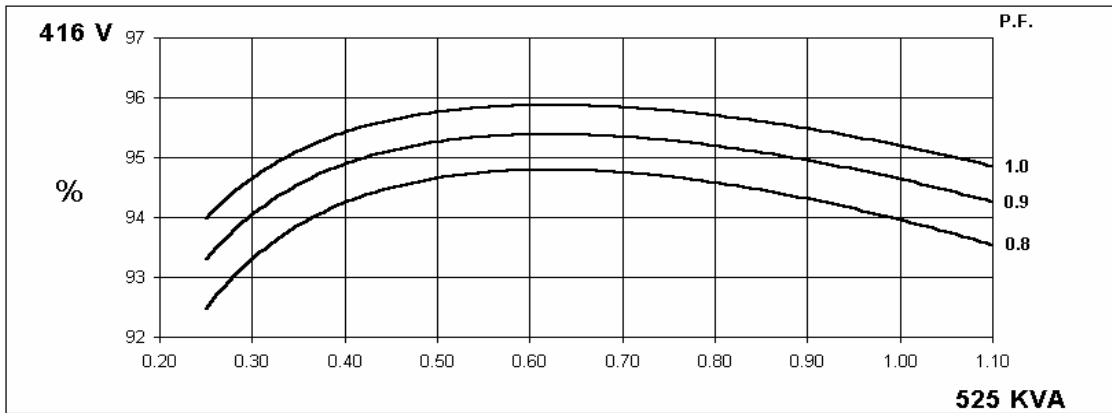

HCI534C/544C

Winding 311



Locked Rotor Motor Starting Curve

**50
Hz**

MX

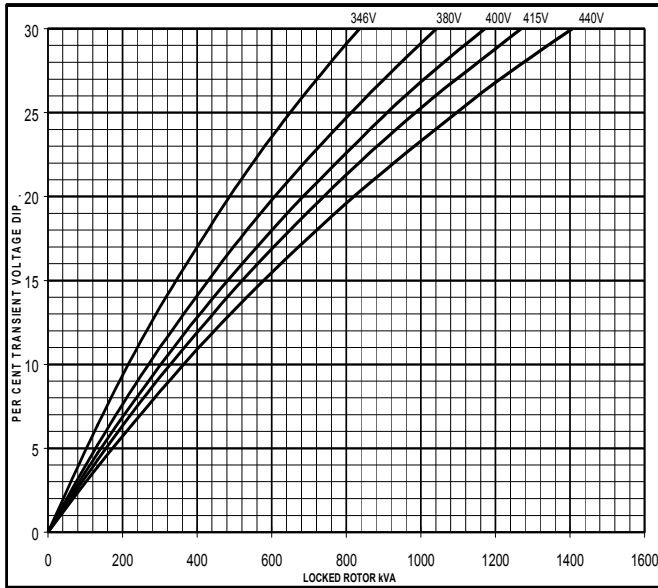

SX

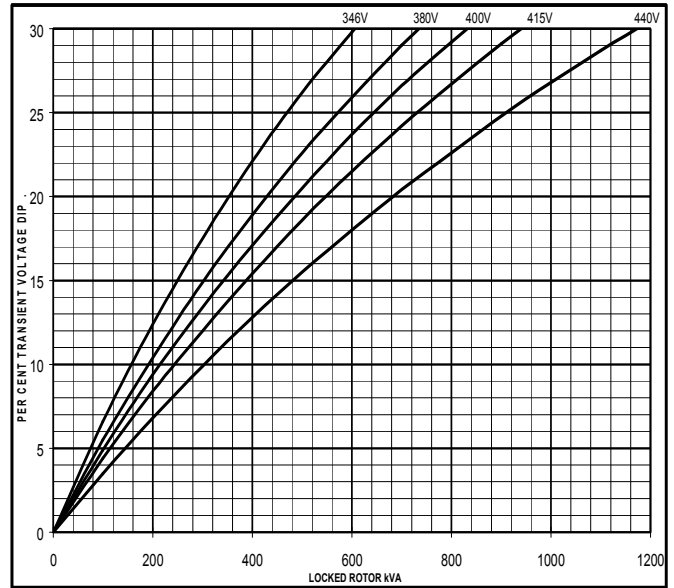

**60
Hz**

MX

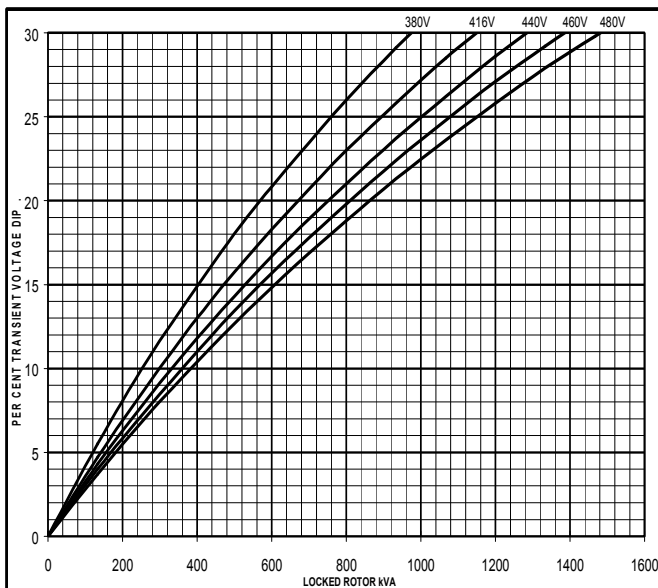

SX

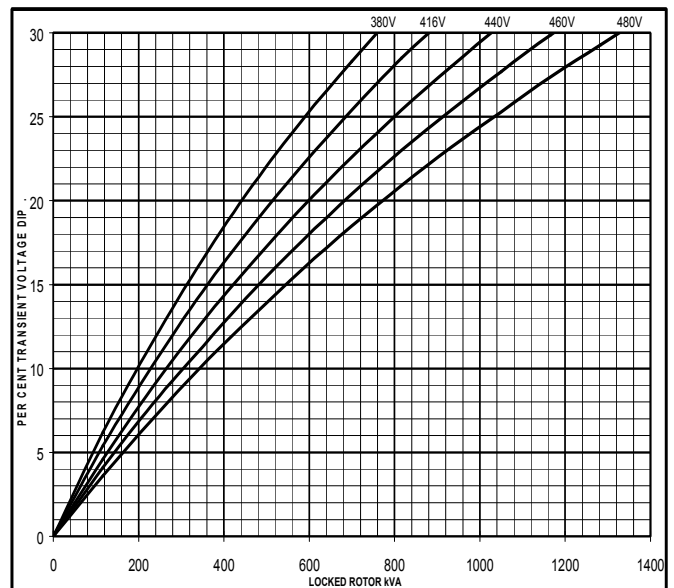

**Three-phase Short Circuit Decrement Curve. No-load Excitation at Rated Speed
Based on star (wye) connection.**

**50
Hz**

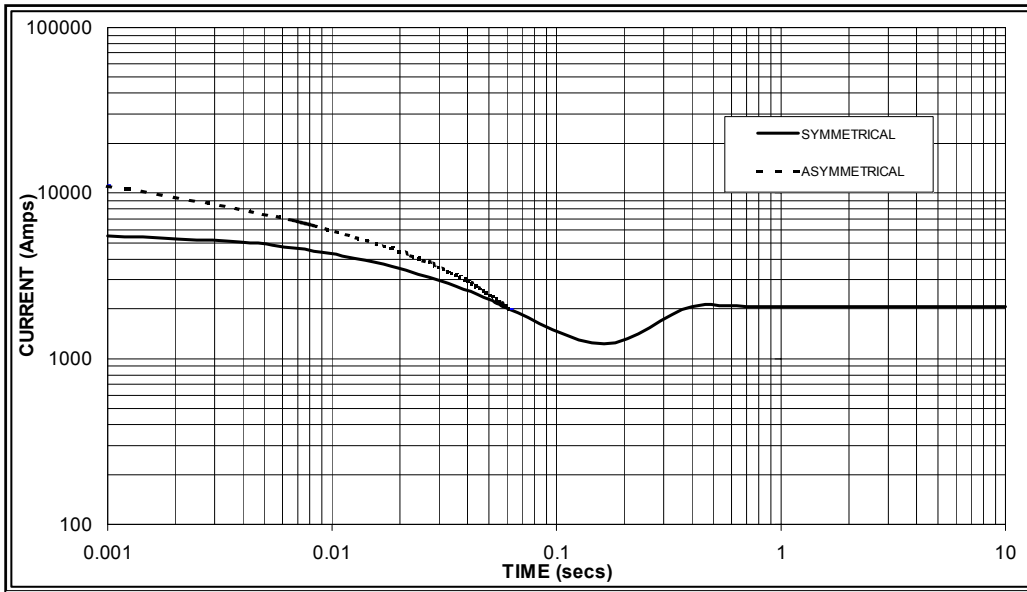

Sustained Short Circuit = 2,050 Amps

**60
Hz**

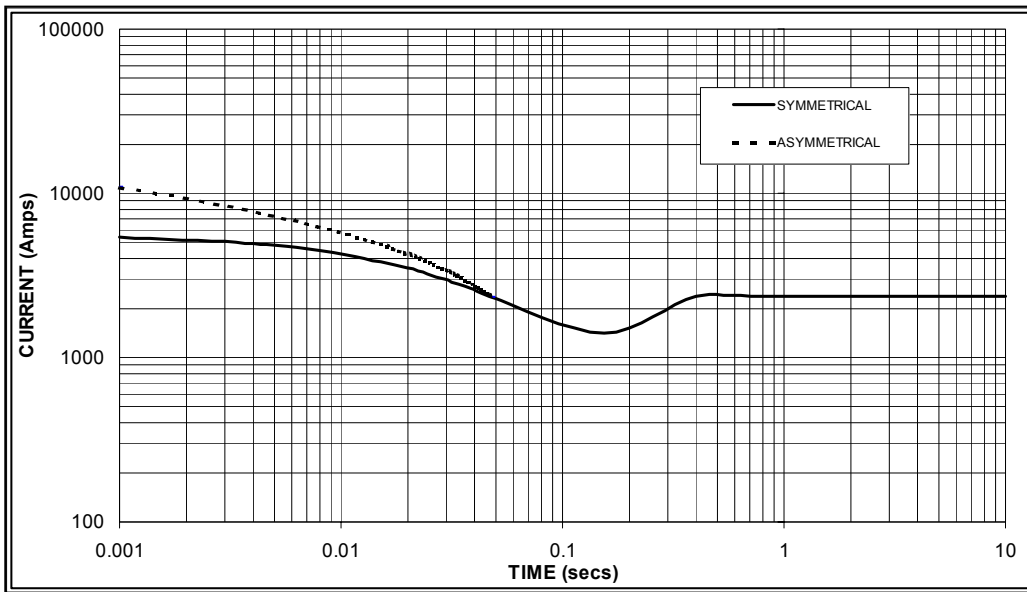

Sustained Short Circuit = 2,350 Amps

Note 1

The following multiplication factors should be used to adjust the values from curve between time 0.001 seconds and the minimum current point in respect of nominal operating voltage :

50Hz		60Hz	
Voltage	Factor	Voltage	Factor
380v	X 1.00	416v	X 1.00
400v	X 1.03	440v	X 1.06
415v	X 1.05	460v	X 1.12
440v	X 1.07	480v	X 1.20

The sustained current value is constant irrespective of voltage level

Note 2

The following multiplication factor should be used to convert the values calculated in accordance with NOTE 1 to those applicable to the various types of short circuit :

	3-phase	2-phase L-L	1-phase L-N
Instantaneous	x 1.00	x 0.87	x 1.30
Minimum	x 1.00	x 1.80	x 3.20
Sustained	x 1.00	x 1.50	x 2.50
Max. sustained duration	10 sec.	5 sec.	2 sec.

All other times are unchanged

Note 3

Curves are drawn for Star (Wye) connected machines. For other connection the following multipliers should be applied to current values as shown :

Parallel Star = Curve current value X 2

Series Delta = Curve current value X 1.732

HCI534C/544C

Winding 311 0.8 Power Factor



RATINGS

Class - Temp Rise	Cont. F - 105/40°C				Cont. H - 125/40°C				Standby - 150/40°C				Standby - 163/27°C				
50 Hz	Series Star (V)	380	400	415	440	380	400	415	440	380	400	415	440	380	400	415	440
	Parallel Star (V)	190	200	208	220	190	200	208	220	190	200	208	220	190	200	208	220
	Series Delta (V)	220	230	240	254	220	230	240	254	220	230	240	254	220	230	240	254
kVA	400	445	400	400	450	500	450	450	478	512	478	478	495	520	495	495	
kW	320	356	320	320	360	400	360	360	382	410	382	382	396	416	396	396	
Efficiency (%)	94.5	94.3	94.8	94.9	94.0	93.8	94.4	94.6	93.8	93.7	94.2	94.4	93.6	93.6	94.1	94.3	
kW Input	339	378	338	337	383	426	381	381	408	437	406	405	423	444	421	420	

60 Hz	Series Star (V)	416	440	460	480	416	440	460	480	416	440	460	480	416	440	460	480
	Parallel Star (V)	208	220	230	240	208	220	230	240	208	220	230	240	208	220	230	240
	Delta (V)	240	254	266	277	240	254	266	277	240	254	266	277	240	254	266	277
kVA	481	500	531	538	525	550	581	594	550	581	613	625	569	600	631	644	
kW	385	400	425	430	420	440	465	475	440	465	490	500	455	480	505	515	
Efficiency (%)	94.3	94.4	94.4	94.5	94.0	94.1	94.1	94.2	93.8	93.9	93.9	94.0	93.6	93.7	93.7	93.9	
kW Input	408	424	450	455	447	468	494	504	469	495	522	532	486	512	539	549	

DIMENSIONS

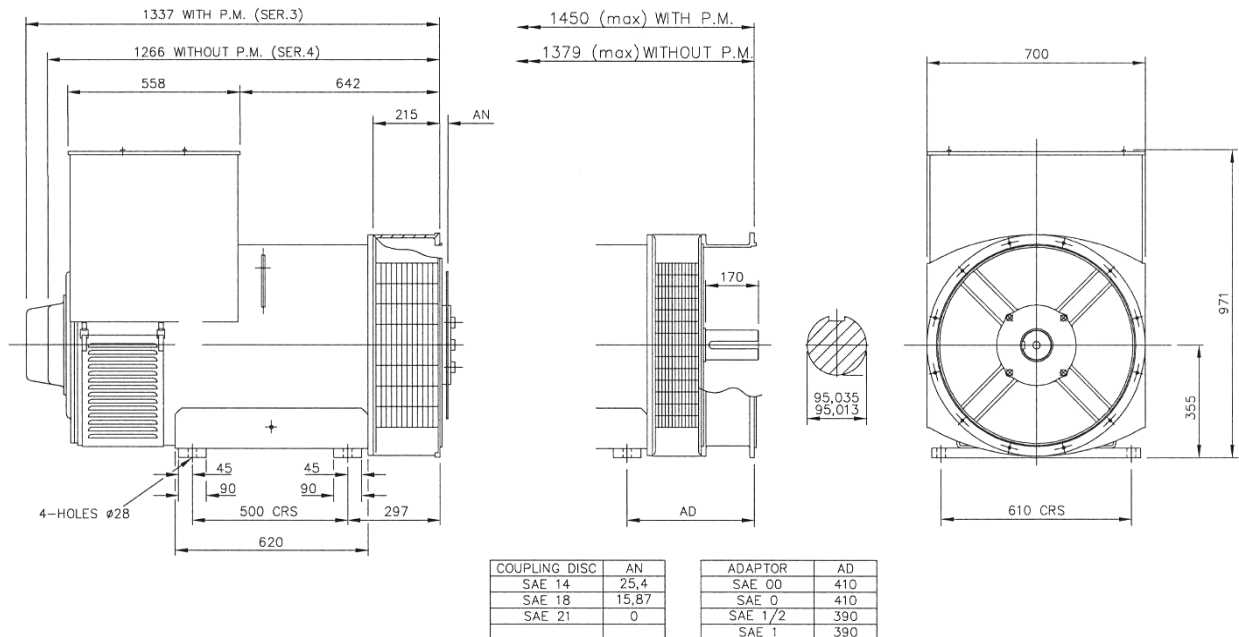

PO Box 17 • Barnack Road • Stamford • Lincolnshire • PE9 2NB
Tel: 00 44 (0)1780 484000 • Fax: 00 44 (0)1780 484100
Website: www.newage-avkseg.com