

S3.8 G7 CoolPac



> Specification sheet

Our energy working for you.™



Description

The Cummins 'S Series' engine powered CoolPac sets offer the lowest cost of maintenance thereby proving to be the most economical power solution. With the robust design and integrated technologies, the 'S Series' CoolPac can command an unrivalled reputation for reliability and performance.

The Cummins 'S Series' engine powered CoolPac sets give you the advantage of optimising your valuable space. All elements of the CoolPac sets are designed from the start to work together to maximize efficiency, even at part loads, thus offering you the advantage of lowest operating costs.

The rugged and reliable Cummins 'S Series' CoolPac sets are unique, because all the major components – the engine and cooling system are manufactured by Cummins India. This integral approach means each element of a CoolPac set is designed to work in harmony from the start.



This engine has been built to comply with CE certification.



This engine has been designed in facilities certified to ISO9001 and manufactured in facilities certified to ISO9001 or ISO9002.

Features

Engine : Cummins 'S Series' CoolPac, powered by Cummins 'S Series' engines, are rated at 1500 RPM and conform to ISO 8528 specifications. The engines are radiator cooled, four stroke and multi-cylinder, conforming to BS 5514/ISO 3046.

The scope of Supply includes :

- Battery Charging Alternator
- Bosch In-line fuel system with mechanical governor
- Dual spin-on fuel filters
- Lube oil filter
- Turbocharger
- Charge Air Cooler (CAC)
- Dry type Air Cleaner
- Coolant recovery bottle
- Fuel pump shut-off coil with Temperature, Pressure & Magnetic Speed sensors
- Flywheel and flywheel housing
- CE compliant guarding
- Oil drain valve

Integrated Design - CoolPac products are supplied fitted with cooling package and medium duty air cleaner for a complete power package. Each component has been specifically developed and rigorously tested for G-Drive products, ensuring high performance, durability and reliability.

Service and Support - G-Drive products are backed by an uncompromising level of technical support and after sales service, delivered through a world class service network.

1500 rpm (50 Hz Ratings)

Gross Engine Output			Net Engine Output			Typical Generator Set Output					
Standby	Prime	Base	Standby	Prime	Base	Standby (ESP)		Prime (PRP)		Base (COP)	
kWm/BHP			kWm/BHP			kWe	kVA	kWe	kVA	kWe	kVA
64.9/87	59.6/79.9	41.7/55.9	62.9/84.2	57.6/77.1	39.7/53.1	52.8	66	48	60	33.6	42

Our energy working for you.™

www.cumminsgdrive.com

©2009 | Cummins G-Drive Engines | Specifications Subject to Change Without Notice | Cummins is a registered trademark of Cummins Inc.



General Engine Data

Type	In line, Radiator cooled
Bore mm	97
Stroke mm	128
Displacement Litre	3.8
Cylinder Block	Cast Iron, 4 Cylinder
Battery Charging Alternator	12V, 35 Amps
Starting Voltage	12V
Fuel System	Direct Injection
Fuel Filter	Spin on
Lube Oil Filter Type(s)	Spin on
Lube Oil Capacity (l)	11
Flywheel Dimensions	SAE3/10

CoolPac Performance Data

Cooling System Design	Charge Air & Jacket Water Cooled
Coolant Ratio	50:50
Coolant Capacity (l)	11
Limiting Ambient Temp. (degC)**	50
Fan Power (Kw)	2
Cooling System Air Flow (m ³ /s)**	0.99
Air Cleaner Type	Dry Type, Replaceable, medium duty

** @ ¼" H₂O

Weight & Dimensions

Length	Width	Height	Weight (dry)
mm	mm	mm	kg
1290	910	1080	500

Fuel Consumption 1500 (50 Hz)

%	kWm	BHP	L/ph	US gal/ph
Standby Power				
100	64.9	87	16.1	4.3
Prime Power				
100	59.6	79.9	14.7	3.9
75	44.7	59.9	11.0	2.9
50	29.8	40	6.1	1.6
25	14.9	20	4.5	1.2
Continuous Power				
100	41.7	55.9	10.6	2.8

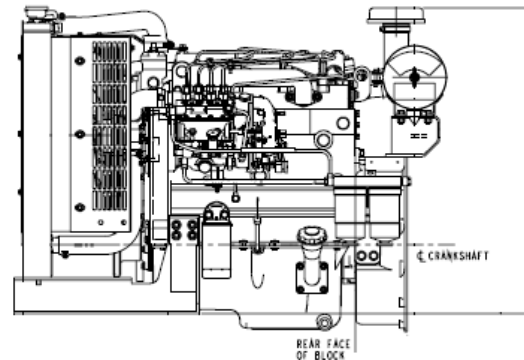

Ratings Definitions

Emergency Standby Power (ESP):

Applicable for supplying power to varying electrical load for the duration of power interruption of a reliable utility source. Emergency Standby Power (ESP) is in accordance with ISO 3046, AS 2789, DIN 6271 and BS 5514.

Limited-Time Running Power (LTP):

Applicable for supplying power to a constant electrical load for limited hours. Limited-Time Running Power (LTP) is in accordance with ISO 8528.

Prime Power (PRP):

Applicable for supplying power to varying electrical load for unlimited hours. Prime Power (PRP) is in accordance with ISO 8528. Ten percent overload capability is available in accordance with ISO 3046, AS 2789, DIN 6271 and BS 5514.

Base Load (Continuous) Power (COP):

Applicable for supplying power continuously to a constant electrical load for unlimited hours. Continuous Power (COP) in accordance with ISO 8528, ISO 3046, AS 2789, DIN6271 and BS 5514.

Cummins G-Drive Engines

Asia Pacific
10 Toh Guan Road
#07-01
TT International Tradepark
Singapore 608838
Phone 65 6417 2388
Fax 65 6417 2399

Europe, CIS, Middle East and Africa
Manston Park Columbus Ave
Manston Ramsgate
Kent CT12 5BF, UK
Phone 44 1843 255000
Fax 44 1843 255902

Latin America
Rua Jati, 310, Cumbica
Guarulhos, SP 07180-900
Brazil
Phone 55 11 2186 4552
Fax 55 11 2186 4729

Mexico
Cummins S. de R.L. de C.V.
Eje 122 No. 200 Zona Industrial
San Luis Potosi, S.L.P. 78090
Mexico
Phone 52 444 870 6700
Fax 52 444 870 6811

North America
1400 73rd Avenue N.E.
Minneapolis, MN 55432
USA
Phone 1 763 574 5000
USA Toll-free 1 877 769 7669
Fax 1 763 574 5298

Our energy working for you.™

www.cumminsgdrive.com

©2009 | Cummins G-Drive Engines | Specifications Subject to Change Without Notice | Cummins is a registered trademark of Cummins Inc.



UCI224E - Technical Data Sheet

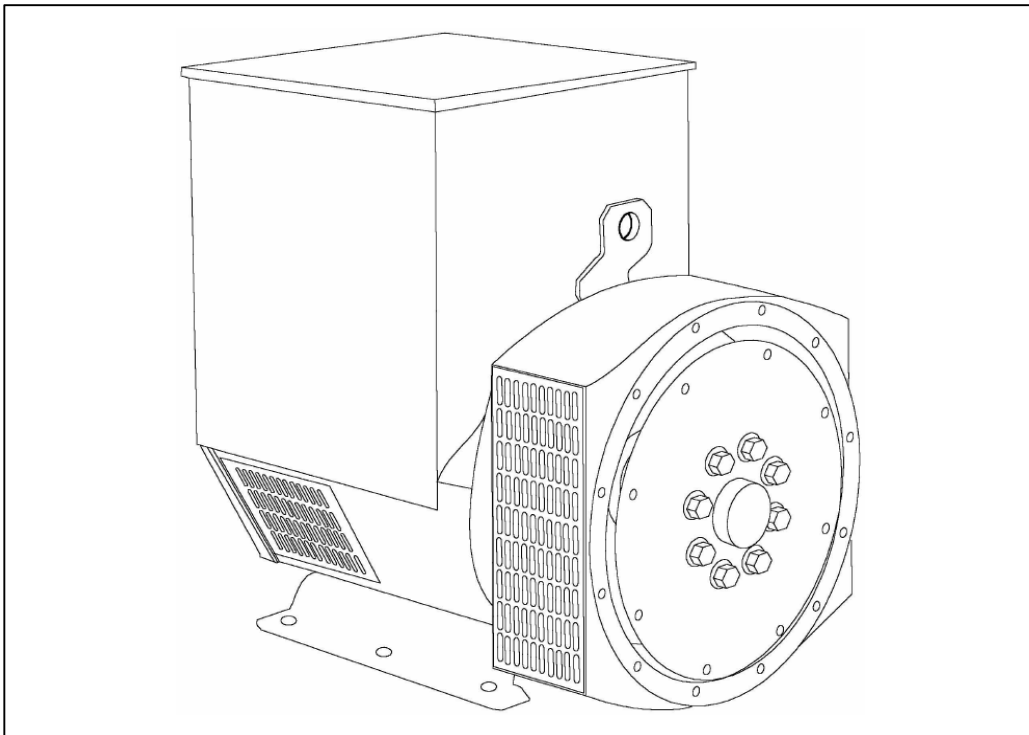

UCI224E

SPECIFICATIONS & OPTIONS



STANDARDS

Newage Stamford industrial generators meet the requirements of BS EN 60034 and the relevant section of other international standards such as BS5000, VDE 0530, NEMA MG1-32, IEC34, CSA C22.2-100, AS1359. Other standards and certifications can be considered on request.

VOLTAGE REGULATORS

SX460 AVR - STANDARD

With this self excited control system the main stator supplies power via the Automatic Voltage Regulator (AVR) to the exciter stator. The high efficiency semiconductors of the AVR ensure positive build-up from initial low levels of residual voltage.

The exciter rotor output is fed to the main rotor through a three phase full wave bridge rectifier. This rectifier is protected by a surge suppressor against surges caused, for example, by short circuit.

SX440 AVR

With this self-excited system the main stator provides power via the AVR to the exciter stator. The high efficiency semi-conductors of the AVR ensure positive build-up from initial low levels of residual voltage.

The exciter rotor output is fed to the main rotor through a three-phase full-wave bridge rectifier. The rectifier is protected by a surge suppressor against surges caused, for example, by short circuit or out-of-phase paralleling.

The SX440 will support a range of electronic accessories, including a 'droop' Current Transformer (CT) to permit parallel operation with other ac generators.

If 3-phase sensing is required with the self-excited system, the SX421 AVR must be used.

SX421AVR

This AVR also operates in a self-excited system. It combines all the features of the SX440 with, additionally, three-phase rms sensing for improved regulation and performance. Over voltage protection is provided via a separate circuit breaker. An engine relief load acceptance feature is built in as standard.

MX341 AVR

This sophisticated AVR is incorporated into the Stamford Permanent Magnet Generator (PMG) control system.

The PMG provides power via the AVR to the main exciter, giving a source of constant excitation power independent of generator output. The main exciter output is then fed to the main rotor, through a full wave bridge, protected by a surge suppressor. The AVR has in-built protection against sustained over-excitation, caused by internal or external faults. This de-excites the machine after a minimum of 5 seconds.

An engine relief load acceptance feature can enable full load to be applied to the generator in a single step.

If three-phase sensing is required with the PMG system the MX321 AVR must be used.

We recommend three-phase sensing for applications with greatly unbalanced or highly non-linear loads.

MX321 AVR

The most sophisticated of all our AVRs combines all the features of the MX341 with, additionally, three-phase rms sensing, for improved regulation and performance. Over voltage protection is built-in and short circuit current level adjustments is an optional facility.

WINDINGS & ELECTRICAL PERFORMANCE

All generator stators are wound to 2/3 pitch. This eliminates triplen (3rd, 9th, 15th ...) harmonics on the voltage waveform and is found to be the optimum design for trouble-free supply of non-linear loads. The 2/3 pitch design avoids excessive neutral currents sometimes seen with higher winding pitches, when in parallel with the mains. A fully connected damper winding reduces oscillations during paralleling. This winding, with the 2/3 pitch and carefully selected pole and tooth designs, ensures very low waveform distortion.

TERMINALS & TERMINAL BOX

Standard generators are 3-phase reconnectable with 12 ends brought out to the terminals, which are mounted on a cover at the non-drive end of the generator. A sheet steel terminal box contains the AVR and provides ample space for the customers' wiring and gland arrangements. It has removable panels for easy access.

SHAFT & KEYS

All generator rotors are dynamically balanced to better than BS6861:Part 1 Grade 2.5 for minimum vibration in operation. Two bearing generators are balanced with a half key.

INSULATION/IMPREGNATION

The insulation system is class 'H'.

All wound components are impregnated with materials and processes designed specifically to provide the high build required for static windings and the high mechanical strength required for rotating components.

QUALITY ASSURANCE

Generators are manufactured using production procedures having a quality assurance level to BS EN ISO 9001.

The stated voltage regulation may not be maintained in the presence of certain radio transmitted signals. Any change in performance will fall within the limits of Criteria 'B' of EN 61000-6-2:2001. At no time will the steady-state voltage regulation exceed 2%.

NB Continuous development of our products entitles us to change specification details without notice, therefore they must not be regarded as binding.

Front cover drawing typical of product range.

UCI224E
WINDING 311

CONTROL SYSTEM	SEPARATELY EXCITED BY P.M.G.							
A.V.R.	MX321	MX341						
VOLTAGE REGULATION	± 0.5 %	± 1.0 %	With 4% ENGINE GOVERNING					
SUSTAINED SHORT CIRCUIT	REFER TO SHORT CIRCUIT DECREMENT CURVES (page 7)							
CONTROL SYSTEM	SELF EXCITED							
A.V.R.	SX460	SX440	SX421					
VOLTAGE REGULATION	± 1.5 %	± 1.0 %	± 0.5 %	With 4% ENGINE GOVERNING				
SUSTAINED SHORT CIRCUIT	SERIES 4 CONTROL DOES NOT SUSTAIN A SHORT CIRCUIT CURRENT							
INSULATION SYSTEM	CLASS H							
PROTECTION	IP23							
RATED POWER FACTOR	0.8							
STATOR WINDING	DOUBLE LAYER CONCENTRIC							
WINDING PITCH	TWO THIRDS							
WINDING LEADS	12							
STATOR WDG. RESISTANCE	0.101 Ohms PER PHASE AT 22°C SERIES STAR CONNECTED							
ROTOR WDG. RESISTANCE	0.69 Ohms at 22°C							
EXCITER STATOR RESISTANCE	20 Ohms at 22°C							
EXCITER ROTOR RESISTANCE	0.078 Ohms PER PHASE AT 22°C							
R.F.I. SUPPRESSION	BS EN 61000-6-2 & BS EN 61000-6-4, VDE 0875G, VDE 0875N. refer to factory for others							
WAVEFORM DISTORTION	NO LOAD < 1.5% NON-DISTORTING BALANCED LINEAR LOAD < 5.0%							
MAXIMUM OVERSPEED	2250 Rev/Min							
BEARING DRIVE END	BALL. 6312-2RS (ISO)							
BEARING NON-DRIVE END	BALL. 6309-2RS (ISO)							
	1 BEARING				2 BEARING			
WEIGHT COMP. GENERATOR	311 kg				330 kg			
WEIGHT WOUND STATOR	103 kg				103 kg			
WEIGHT WOUND ROTOR	95.89 kg				87.52 kg			
WR ² INERTIA	0.4999 kgm ²				0.4682 kgm ²			
SHIPPING WEIGHTS in a crate	334 kg				351 kg			
PACKING CRATE SIZE	105 x 57 x 96(cm)				105 x 57 x 96(cm)			
	50 Hz				60 Hz			
TELEPHONE INTERFERENCE	THF<2%				TIF<50			
COOLING AIR	0.216 m ³ /sec 458 cfm				0.281 m ³ /sec 595 cfm			
VOLTAGE SERIES STAR	380/220	400/231	415/240	440/254	416/240	440/254	460/266	480/277
VOLTAGE PARALLEL STAR	190/110	200/115	208/120	220/127	208/120	220/127	230/133	240/138
VOLTAGE SERIES DELTA	220/110	230/115	240/120	254/127	240/120	254/127	266/133	277/138
KVA BASE RATING FOR REACTANCE VALUES	60	60	60	58	67.5	70	72.5	75
X _d DIR. AXIS SYNCHRONOUS	2.48	2.24	2.08	1.79	3.00	2.78	2.64	2.50
X' _d DIR. AXIS TRANSIENT	0.19	0.17	0.16	0.14	0.22	0.20	0.19	0.18
X'' _d DIR. AXIS SUBTRANSIENT	0.13	0.12	0.11	0.09	0.15	0.14	0.13	0.13
X _q QUAD. AXIS REACTANCE	1.13	1.02	0.95	0.82	1.38	1.28	1.21	1.15
X'' _q QUAD. AXIS SUBTRANSIENT	0.14	0.13	0.12	0.10	0.14	0.13	0.12	0.12
X _L LEAKAGE REACTANCE	0.08	0.08	0.07	0.06	0.09	0.08	0.08	0.08
X ₂ NEGATIVE SEQUENCE	0.13	0.12	0.11	0.09	0.14	0.13	0.12	0.12
X ₀ ZERO SEQUENCE	0.11	0.10	0.09	0.08	0.09	0.08	0.08	0.08
REACTANCES ARE SATURATED				VALUES ARE PER UNIT AT RATING AND VOLTAGE INDICATED				
T' _d TRANSIENT TIME CONST.	0.028 s							
T'' _d SUB-TRANSTIME CONST.	0.007 s							
T' _{do} O.C. FIELD TIME CONST.	0.7 s							
T _a ARMATURE TIME CONST.	0.006 s							
SHORT CIRCUIT RATIO	1/X _d							

**50
Hz**

UCI224E
Winding 311



THREE PHASE EFFICIENCY CURVES

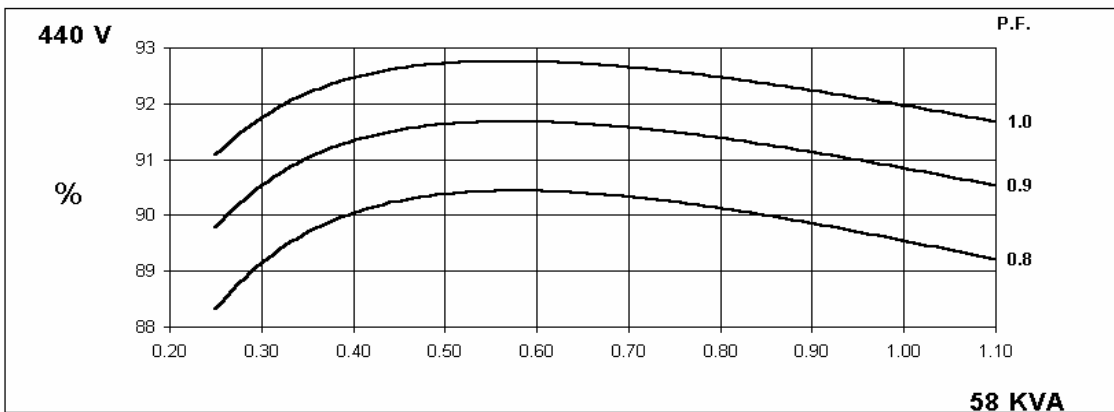
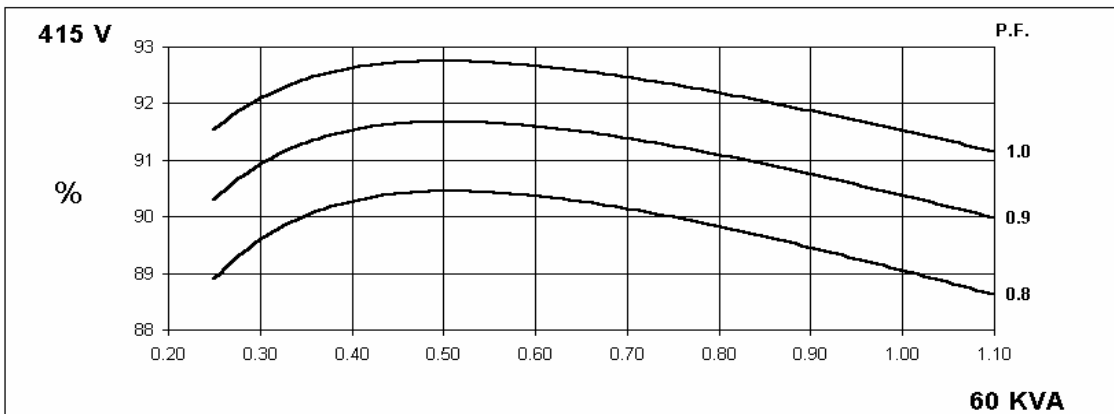
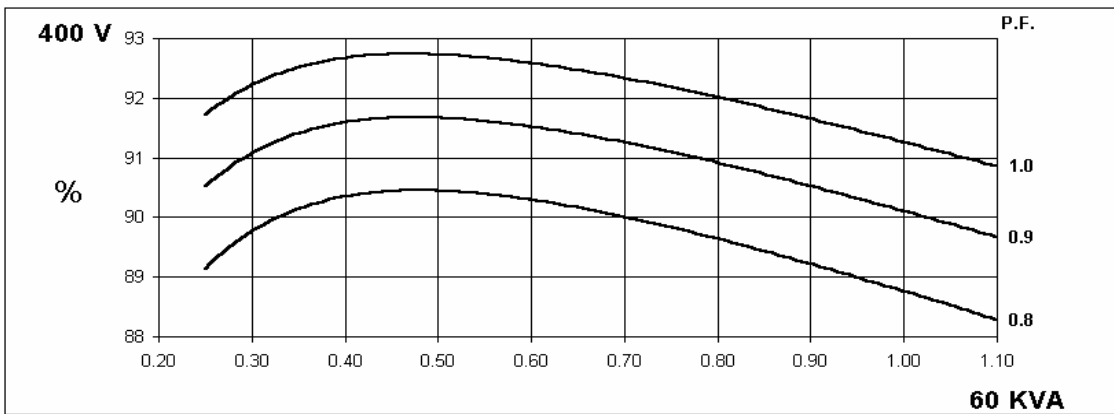
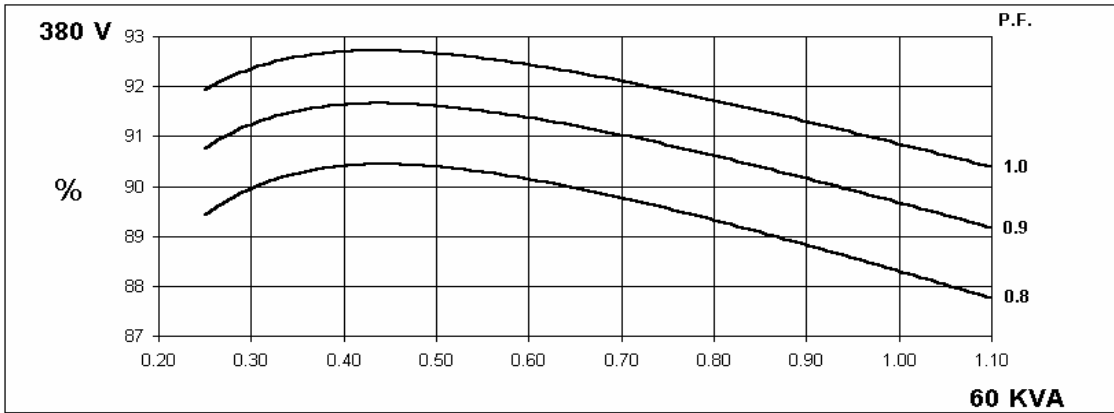

THREE PHASE EFFICIENCY CURVES

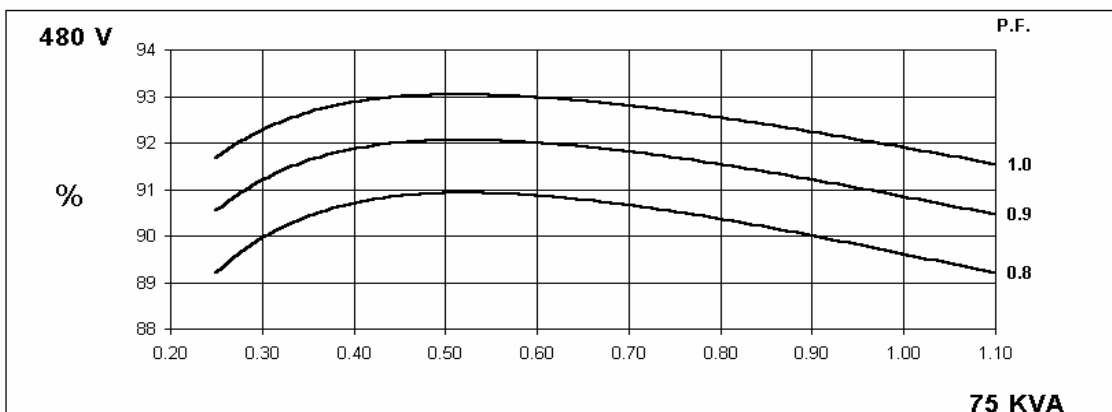
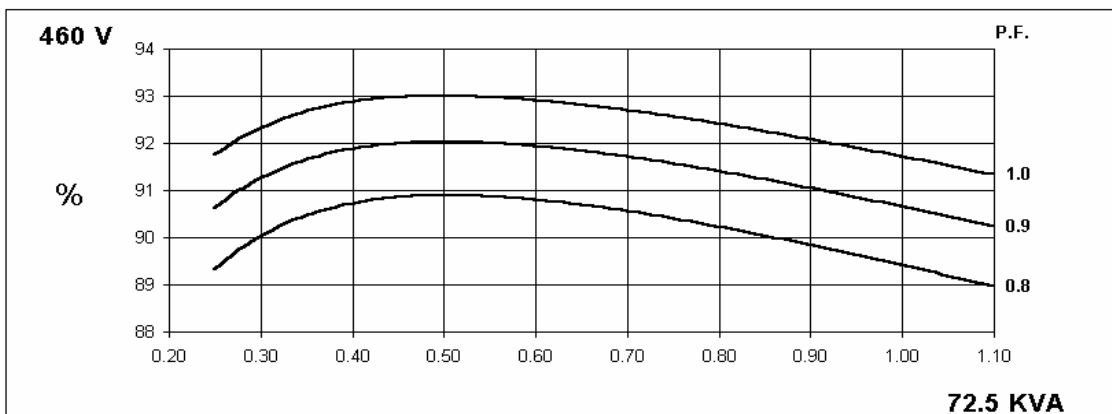
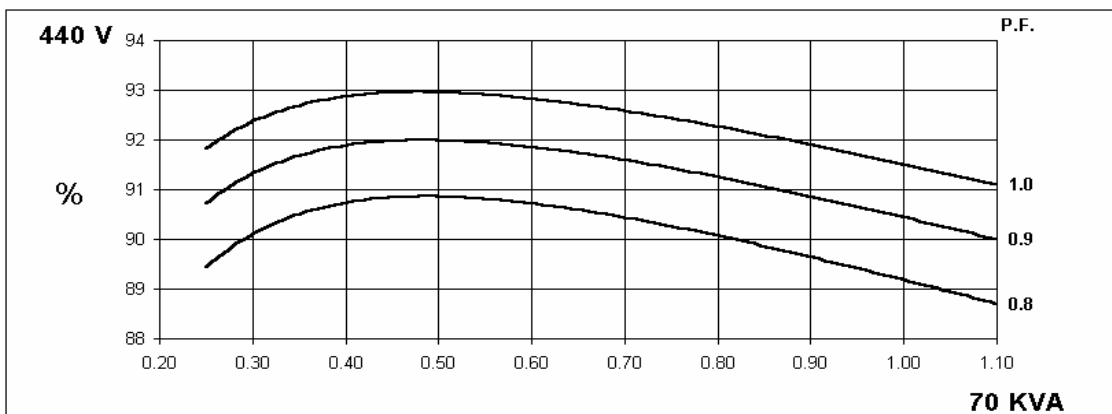
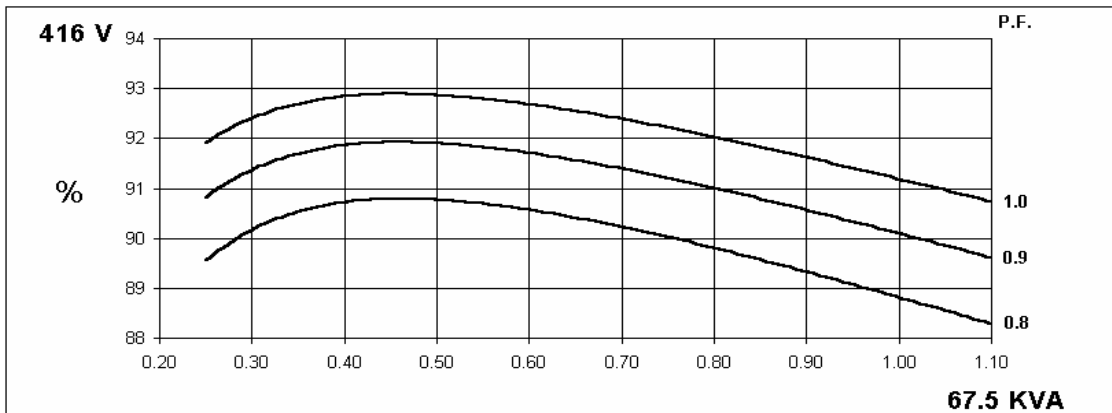

UCI224E

Winding 311



Locked Rotor Motor Starting Curve

**50
Hz**

MX

SX

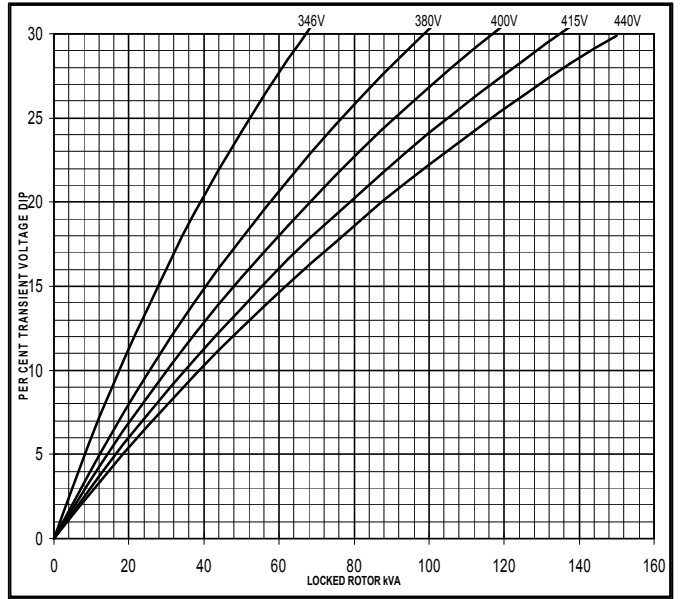
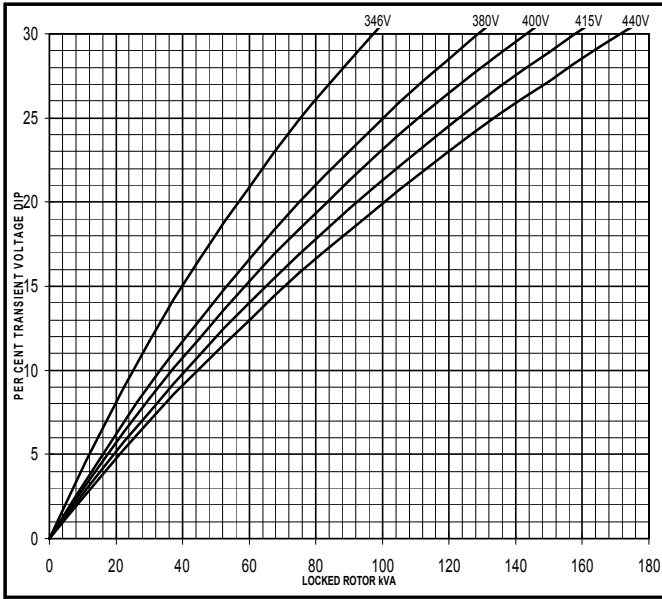

**60
Hz**

MX

SX

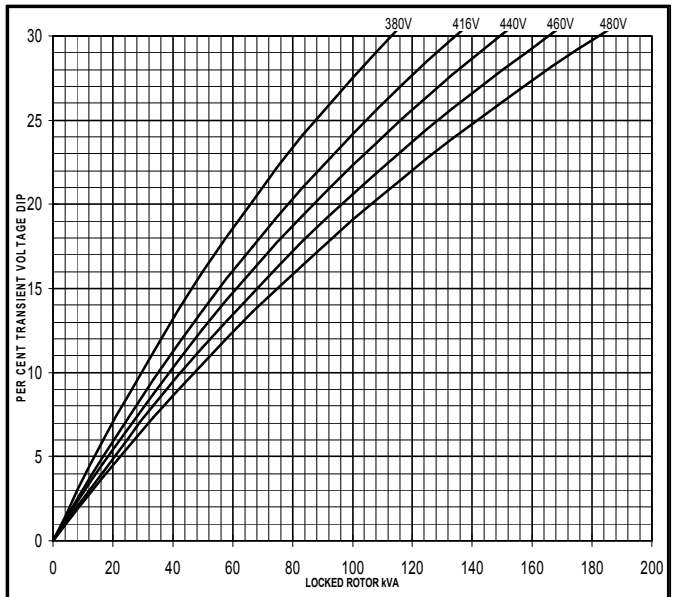
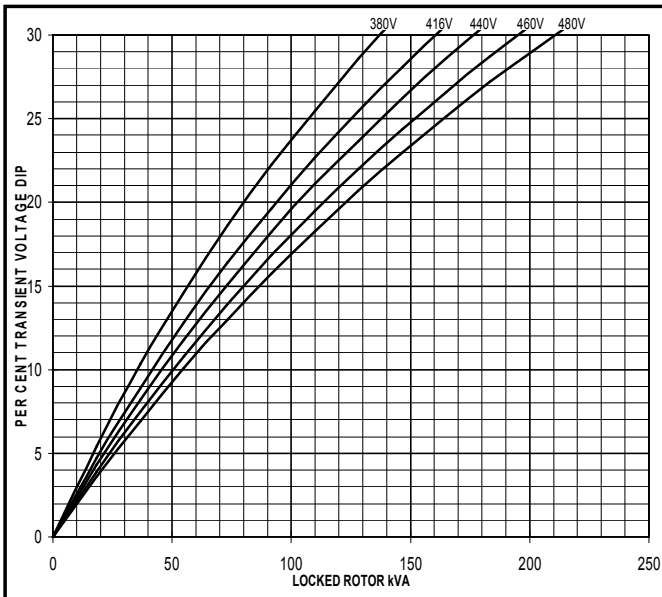

**Three-phase Short Circuit Decrement Curve. No-load Excitation at Rated Speed
Based on star (wye) connection.**

**50
Hz**

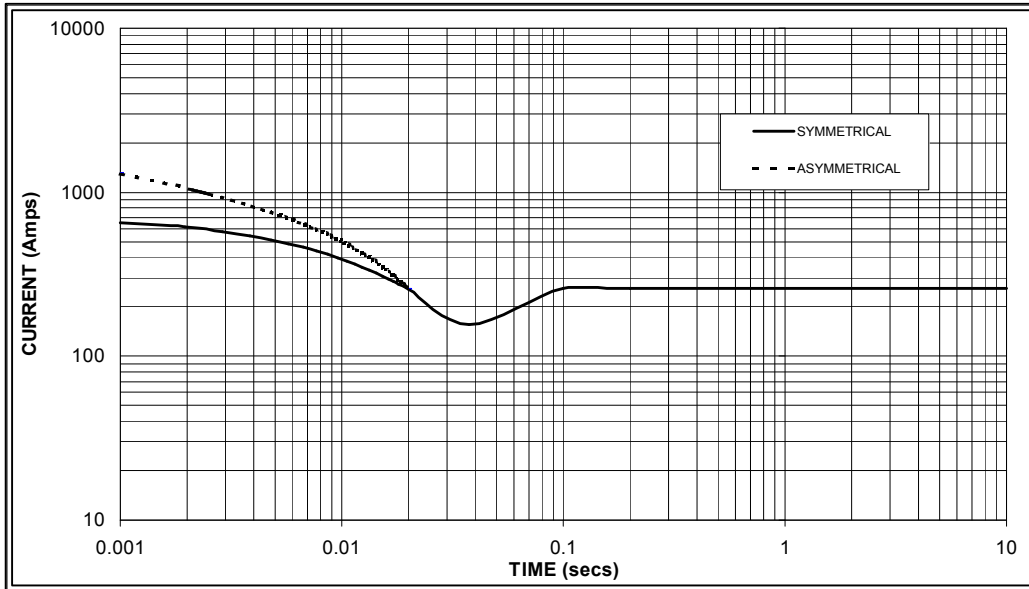

Sustained Short Circuit = 260 Amps

**60
Hz**

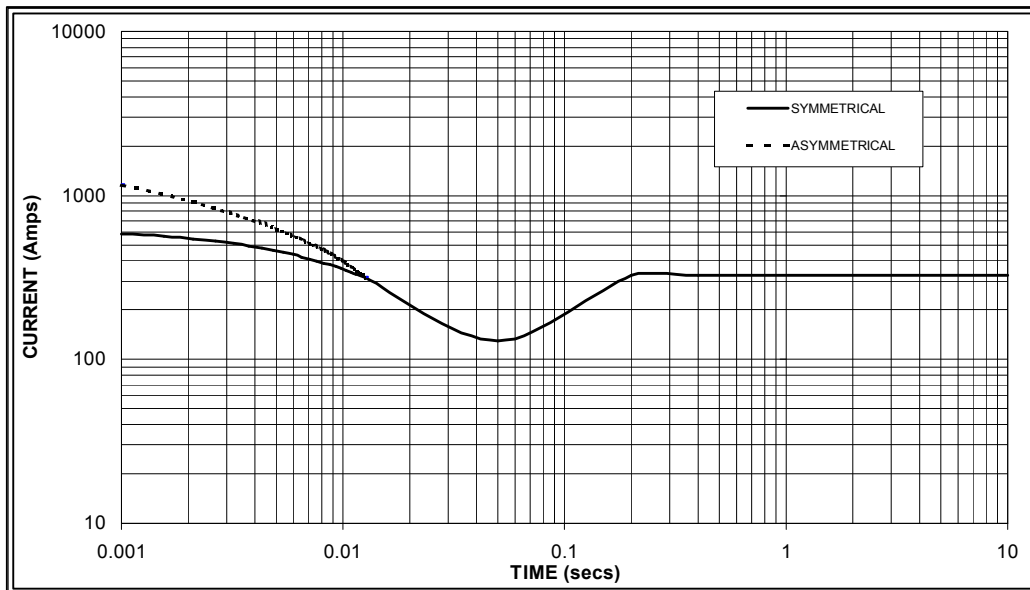

Sustained Short Circuit = 325 Amps

Note 1

The following multiplication factors should be used to adjust the values from curve between time 0.001 seconds and the minimum current point in respect of nominal operating voltage :

50Hz		60Hz	
Voltage	Factor	Voltage	Factor
380v	X 1.00	416v	X 1.00
400v	X 1.07	440v	X 1.06
415v	X 1.12	460v	X 1.12
440v	X 1.18	480v	X 1.17

The sustained current value is constant irrespective of voltage level

Note 2

The following multiplication factor should be used to convert the values calculated in accordance with NOTE 1 to those applicable to the various types of short circuit :

	3-phase	2-phase L-L	1-phase L-N
Instantaneous	x 1.00	x 0.87	x 1.30
Minimum	x 1.00	x 1.80	x 3.20
Sustained	x 1.00	x 1.50	x 2.50
Max. sustained duration	10 sec.	5 sec.	2 sec.

All other times are unchanged

Note 3

Curves are drawn for Star (Wye) connected machines. For other connection the following multipliers should be applied to current values as shown :

Parallel Star = Curve current value X 2

Series Delta = Curve current value X 1.732

UCI224E

Winding 311 / 0.8 Power Factor



RATINGS

Class - Temp Rise	Cont. F - 105/40°C				Cont. H - 125/40°C				Standby - 150/40°C				Standby - 163/27°C				
50 Hz	Series Star (V)	380	400	415	440	380	400	415	440	380	400	415	440	380	400	415	440
	Parallel Star (V)	190	200	208	220	190	200	208	220	190	200	208	220	190	200	208	220
	Series Delta (V)	220	230	240	254	220	230	240	254	220	230	240	254	220	230	240	254
kVA	53.0	53.0	53.0	40.3	60.0	60.0	60.0	45.0	61.0	61.0	61.0	45.8	63.0	63.0	63.0	47.3	
kW	42.4	42.4	42.4	32.2	48.0	48.0	48.0	36.0	48.8	48.8	48.8	36.6	50.4	50.4	50.4	37.8	
Efficiency (%)	88.9	89.3	89.5	89.9	88.3	88.8	89.1	89.5	88.2	88.7	89.0	89.5	88.0	88.5	88.8	89.4	
kW Input	47.7	47.5	47.4	46.3	54.4	54.1	53.9	51.8	55.3	55.0	54.8	52.7	57.3	56.9	56.8	54.6	

60 Hz	Series Star (V)	416	440	460	480	416	440	460	480	416	440	460	480	416	440	460	480
	Parallel Star (V)	208	220	230	240	208	220	230	240	208	220	230	240	208	220	230	240
	Delta (V)	240	254	266	277	240	254	266	277	240	254	266	277	240	254	266	277
kVA	62.5	65.0	65.0	68.0	67.5	70.0	72.5	75.0	70.0	73.8	73.8	78.8	72.5	75.0	75.0	80.0	
kW	50.0	52.0	52.0	54.4	54.0	56.0	58.0	60.0	56.0	59.0	59.0	63.0	58.0	60.0	60.0	64.0	
Efficiency (%)	89.2	89.5	89.9	90.0	88.8	89.2	89.4	89.6	88.6	88.9	89.3	89.4	88.4	88.8	89.3	89.3	
kW Input	56.1	58.1	57.8	60.4	60.8	62.8	64.9	67.0	63.2	66.4	66.1	70.5	65.6	67.6	67.2	71.7	

DIMENSIONS

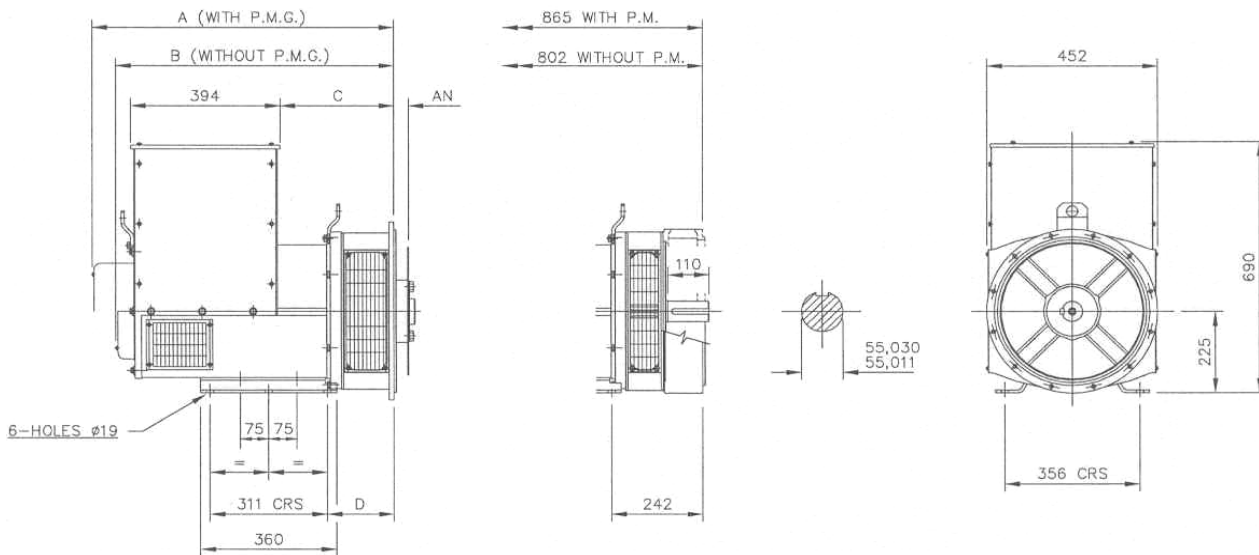

SINGLE BEARING MACHINES ONLY						
ADAPTOR	A	B	C	D	COUPLING DISCS	AN
SAE 1	814,3	751,3	314,3	191,3	SAE 8	61,90
SAE 2	800	737	300	177	SAE 10	53,98
SAE 3	800	737	300	177	SAE 11,5	39,68
SAE 4	800	737	300	177	SAE 14	25,40



Barnack Road • Stamford • Lincolnshire • PE9 2NB
 Tel: 00 44 (0)1780 484000 • Fax: 00 44 (0)1780 484100
 Website: www.newage-avkseg.com