

ژنراتور : Mecc Alte

موتور دیزل : Volvo Penta

Standby		Prime		دیزل ژنراتور
KVA	KW	KVA	KW	
387	-	252	-	









# GENERATOR TYPE ECO 38-3LN/4

Document : DS075A/1

issue 004 date 28/10/2013

Electrical Characteristics										
Frequency	Hz	50				60				
Voltage (series star)	V	380	400	415	440	415	440	460	480	
Rated power class H	kVA	350	350	350	340	380	420	420	420	
	kW	280	280	280	272	304	336	336	336	
Rated power class F	kVA	320	320	320	310	350	385	385	385	
	kW	256	256	256	248	280	308	308	308	
Regulation with DSR		±1 % with any power factor and speed variations between -5% +30%								
Insulation class		H								
Execution		Brushless								
Stator winding		12 ends								
Rotor		with damping cage								
Efficiencies class H	4/4	%	93,4	93,5	93,2	93	93,6	94,1	94,2	94,3
(see graph. for details)	3/4	%	93,4	93,7	93,6	93,3	93,9	94,1	94,3	94,5
	2/4	%	92,5	92,6	92,6	92,4	93	93,1	93,2	93,3
	1/4	%	90,1	89,9	89,7	89,5	90,6	90,6	90,6	90,4
Reactances (f. l.cl. F)	Xd	%	238,2	215	199,7	172,6	260,2	255,9	234,1	215
	Xd'	%	19,1	17,2	16,0	13,8	20,8	20,5	18,7	17,2
	Xd''	%	10,4	9,4	8,7	7,5	11,4	11,2	10,2	9,4
	Xq	%	139,6	126	117,1	101,2	152,5	150,0	137,2	126
	Xq'	%	139,6	126	117,1	101,2	152,5	150,0	137,2	126
	Xq''	%	22,3	20,1	18,7	16,1	24,3	23,9	21,9	20,1
	X <sub>2</sub>	%	17,4	15,7	14,6	12,6	19,0	18,7	17,1	15,7
	X <sub>0</sub>	%	2,4	2,2	2,0	1,8	2,7	2,6	2,4	2,2
Short Circuit Ratio	Kcc		0,37	0,42	0,57	0,92	0,24	0,32	0,37	0,42
Time Constants	Td'	sec.	0,099							
	Td''	sec.	0,0127							
	Tdo'	sec.	1,50							
	Tα	sec.	0,013							
Short Circuit Current Capacity		%	>300				>350			
Excitation at no load	Amp.		0,55	0,72	0,95	1,2	0,35	0,35	0,6	0,7
Excitation at full load	Amp.		3,5	3,9	4,1	4,3	3,3	3,5	3,7	3,9
Overload (long-term)		%	1 hour in a 6 hours period 110% rated load							
Overload per 20 sec.		%	300							
Stator Winding Resistance (20 °C)		Ω	0,0042							
Rotor Winding Resistance (20 °C)		Ω	6,780							
Exciter Resistance (20 °C)		Ω	Rotor : 0,685				Stator : 15,28			
Heat dissipation at f.l.cl.H	W		19786	19465	20429	20473	20786	21067	20688	20310
Telephone Interference			THF < 2%				TIF < 40			
Radio interference			EN61000-6-3, EN61000-6-2. For others standards apply to factory							
Waveform Distors.(THD) at f. load	LL/LN %		3,1 / 2,9							
Waveform Distors.(THD) at no load	LL/LN %		2,7 / 2,7							
<b>Mechanical characteristics</b>										
Protection			IP 21 (other protection on request)							
DE bearing			6318.2RS							
NDE bearing			6314.2RS							
Weight of wound stator assembly	kg		347							
Weight of wound rotor assembly	kg		230							
Weight of complete generator	kg		905							
Maximun overspeed	rpm		2250							
Unbalanced magnetic pull at f.l.cl.F	kN/mm		6,2							
Cooling air requirement	m <sup>3</sup> /min		32				39			
Inertia Constant (H)	sec.		0,123				0,147			
Noise level at 1m/7m	dB(A)		82 / 69				86 / 73			

All technical data are to be considered as a reference and they can be modified without any notice.

This document is a propriety of Mecc Alte S.p.a..All rights reserved.



# GENERATOR TYPE ECO 38-3LN/4

Document : DS075A/2

issue 004 date : 28/10/2013

## 50 Hz

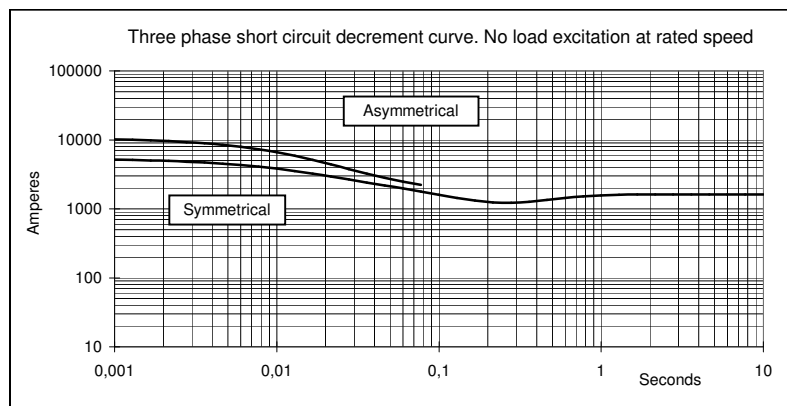
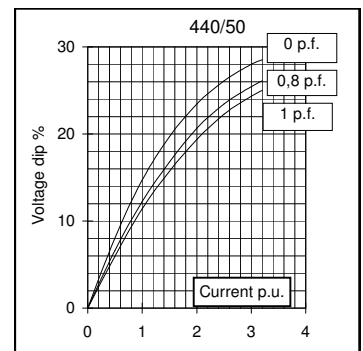
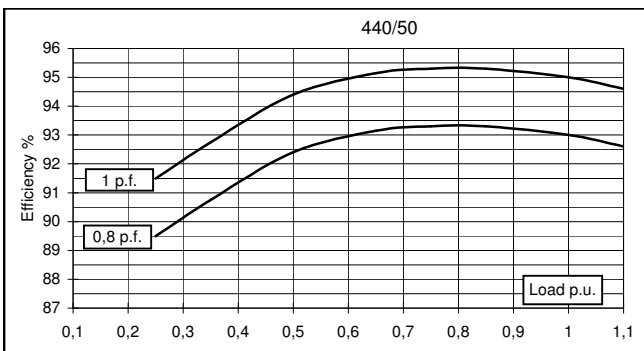
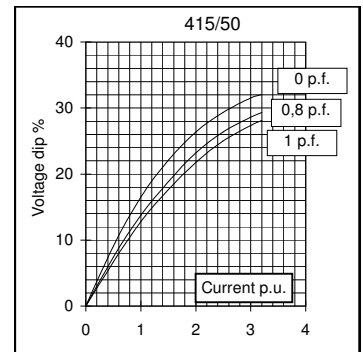
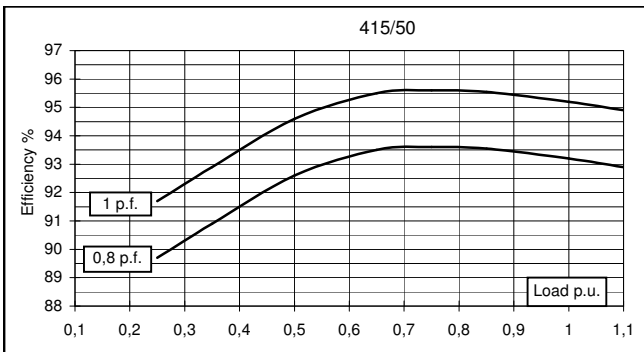
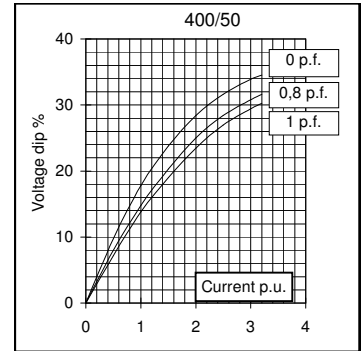
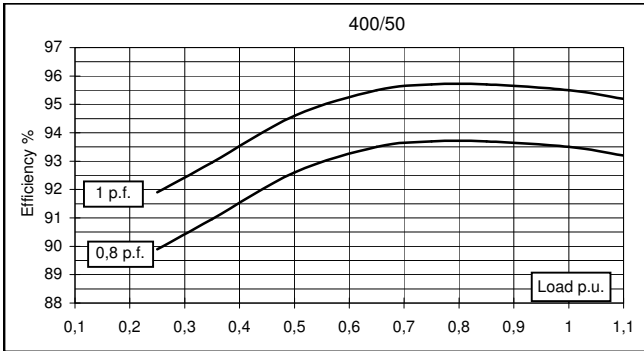
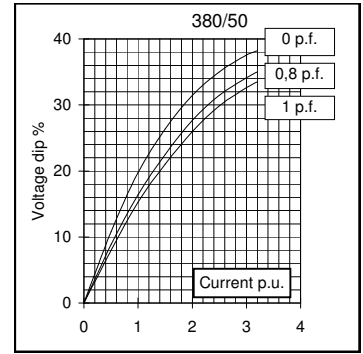
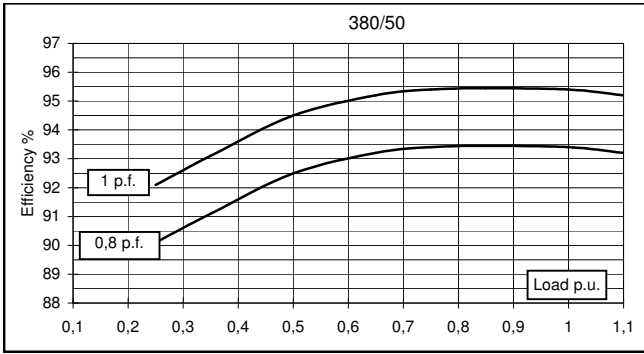



# GENERATOR TYPE ECO 38-3LN/4

Document : DS075A/3  
issue 004 date : 28/10/2013

## 60 Hz

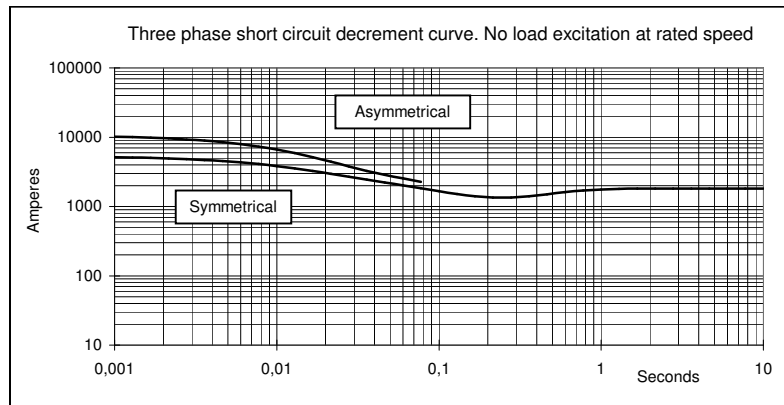
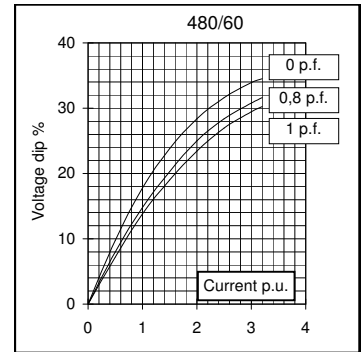
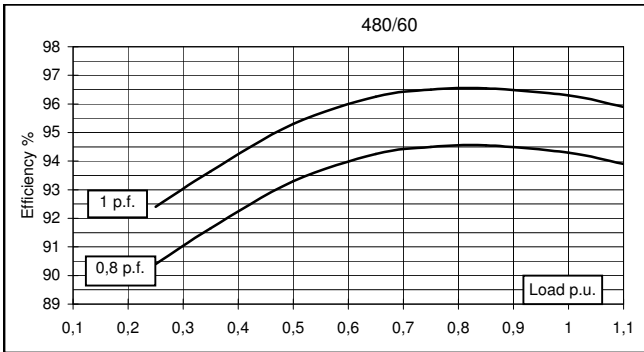
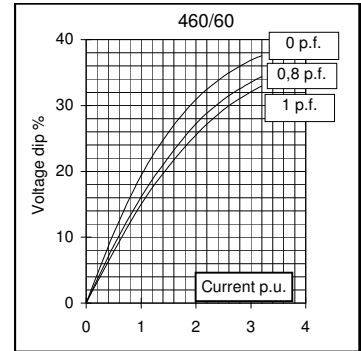
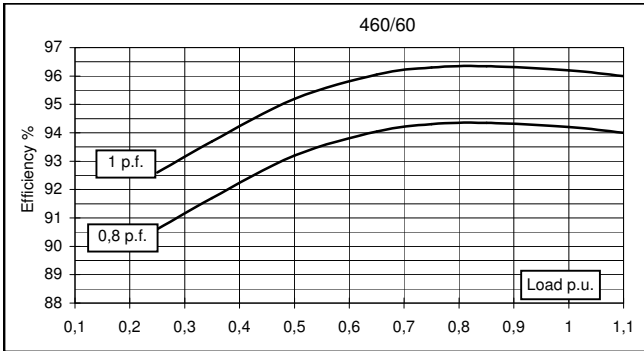
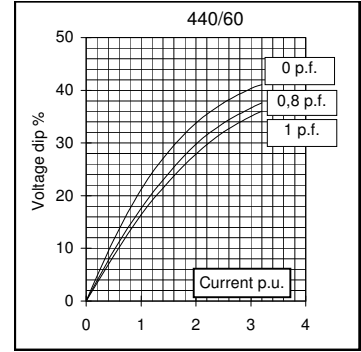
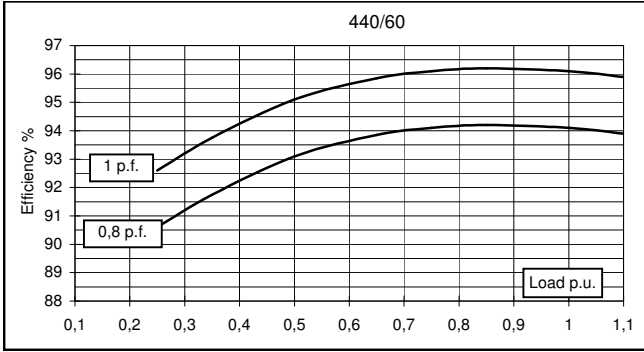
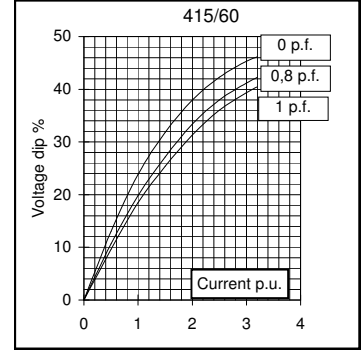
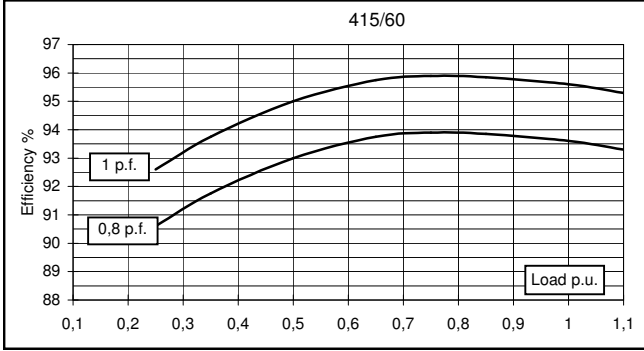

### TWO BEARING MOMENTS OF INERTIA

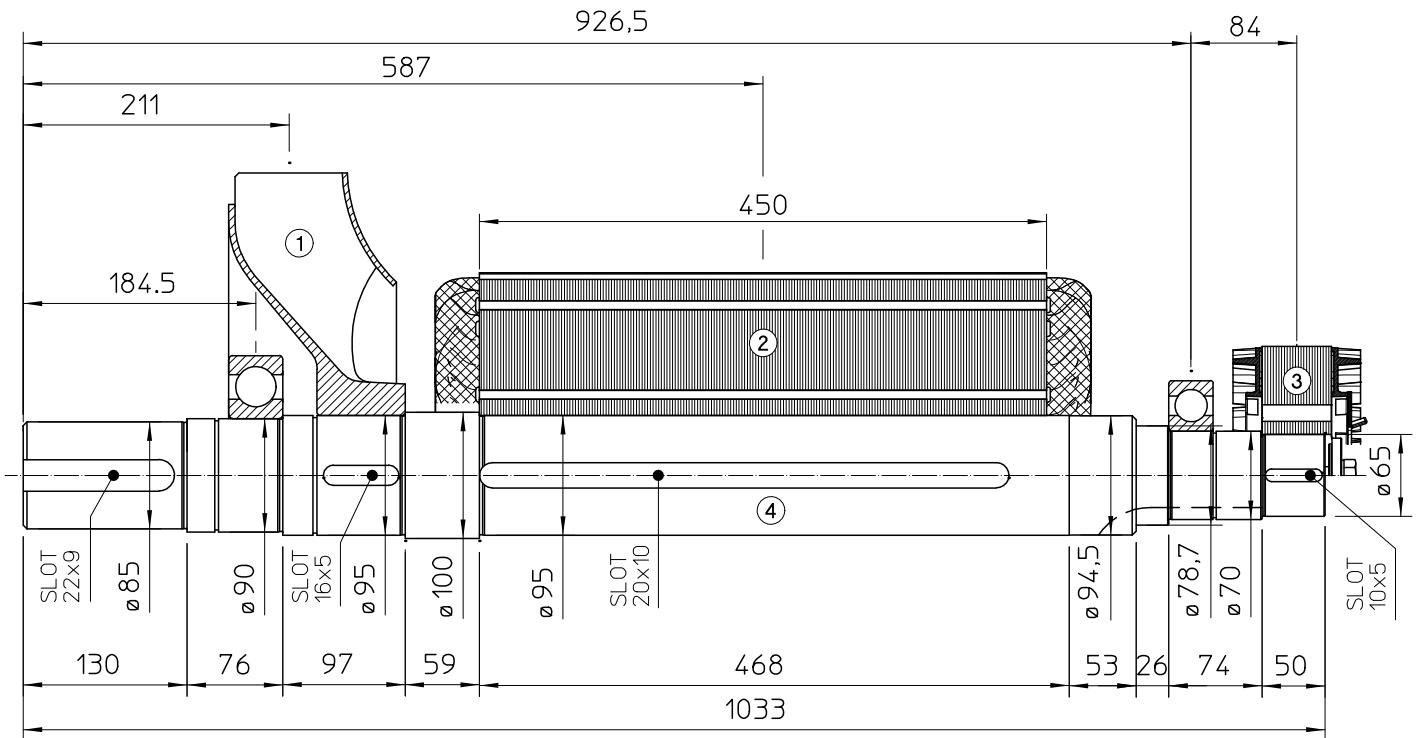

POS.	COMPONENT	WEIGHT (kg)	J (kgm <sup>2</sup> )
1	FAN	6.1	0.1887
2	MAIN ROTOR	230	3.1461
3	EX. ROTOR	14.5	0.0874
4	SHAFT	49.9	0.0525
TOTAL		300.5	3.4747

### TWO BEARING DIMENSIONS

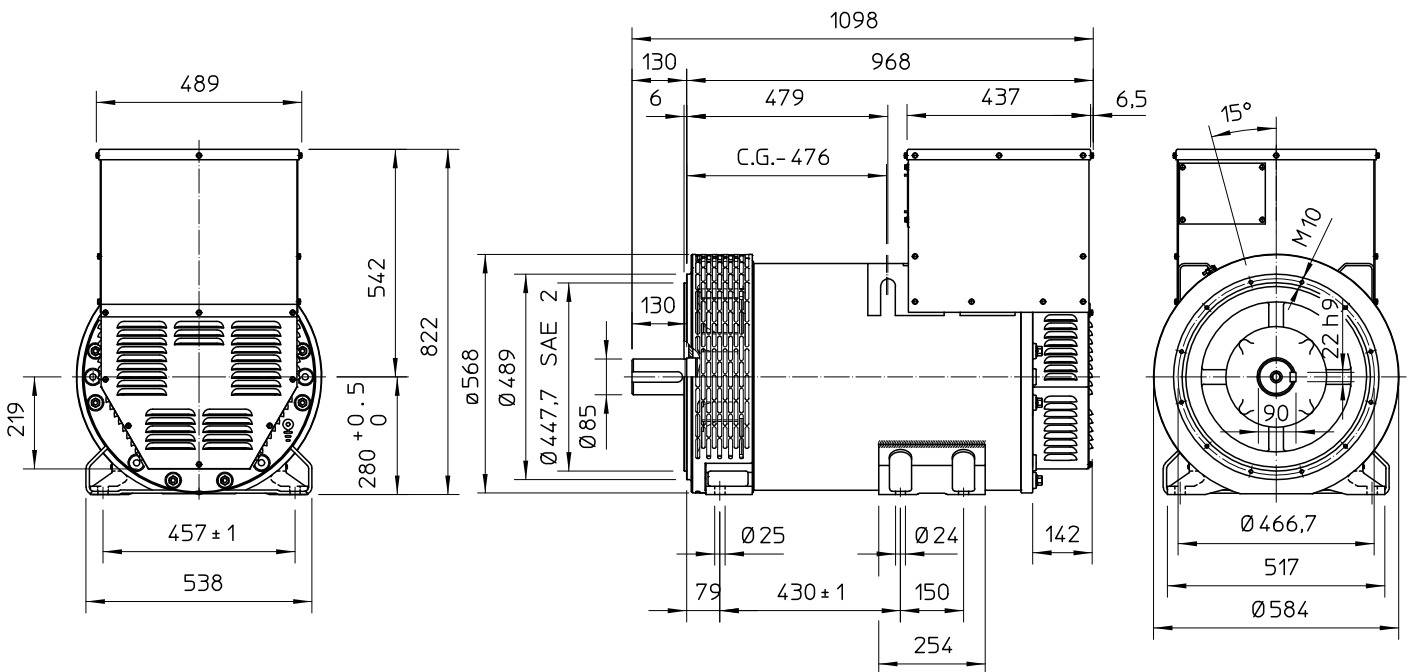

C.G.= GRAVITY CENTER

